

LM10

Incremental Magnetic Encoder

ROBUST

UNIQUE
REFERENCE
MARK

WEAR-FREE
MEASURING
PRINCIPLE

The LM10 is a non-contact high-speed magnetic encoder designed for linear or rotary motion sensing in harsh environments. It features a compact readhead that rides at up to 1.0 mm from the self-adhesive magnetic scale or ring.

Simple to install, the LM10 features a set-up LED and wide installation tolerances. The encoder comes in digital or analogue output variants and offers a range of customer selectable resolutions from 0.244 μm to 250 μm .



Features and benefits

- ▶ Customer selectable resolutions
- ▶ High speed operation
- ▶ Excellent dirt immunity to IP68
- ▶ Linear or rotary position sensing
- ▶ Unique bidirectional reference mark
- ▶ Non-contact and wear-free measuring principle
- ▶ CE compliant, including RoHS
- ▶ Highly resistant to shock, vibration and pressure



INDUSTRIAL AUTOMATION



ASSEMBLY LINES



LINEAR MOTOR



PRINTING TECHNOLOGY



LABORATORY EQUIPMENT

General information

Engineered for extreme service, the solid-state LM10 linear encoders operate from $-10\text{ }^{\circ}\text{C}$ to $+80\text{ }^{\circ}\text{C}$, have water-proof sealing to IP68 and are highly resistant to shock, vibration and pressure. The robust magnetic scale and ring are also resistant to various chemicals commonly found in industry. The non-contact, frictionless design eliminates wear and reduces hysteresis.

Choose your LM10 system

The robust LM10 readhead is compatible with the RLS MS10 incremental scale as well as the RLS axial and radial rings. You can select the length of the MS scale up to 150 m. There is also a wide range of axial and radial incremental rings available.

LM10 + magnetic scale



More about the MS magnetic scales can be found in the MSD01 at [RLS Media center](#).

LM10 + radial ring



More about the radial rings can be found in the MR02D02 at [RLS Media center](#).

LM10 + axial ring



More about the axial rings can be found in the MR01D01 at [RLS Media center](#).

Encoder variants

LM10



LM10 readhead comes with analogue 1 Vpp, incremental quadrature RS422, Push-pull or Open collector outputs.

LM10 + cable with flexible stainless-steel conduit



LM10 with cable with flexible stainless-steel conduit which is excellent for harsh environments. It comes with standard LM10 outputs.

Storage and handling

All data given below refer to the readhead only. Complete systems with magnetic scale or ring may have other limitations. For more information, see the MSD01, MR01D01 or MR02D02 data sheet at [RLS Media center](#).

Storage temperature



-40 °C to +85 °C

Operating temperature



-10 °C to +80 °C

IP protection



IP68

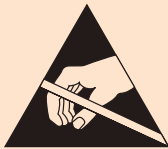
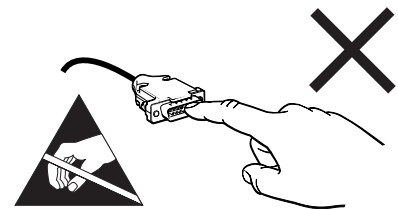
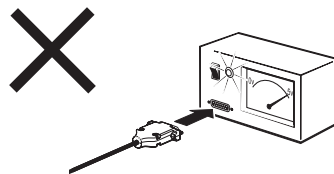
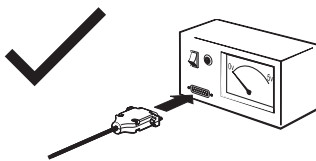

Readhead is ESD sensitive - handle with care.

Do not touch electronic circuit, wires or sensor area without proper ESD protection or outside of ESD controlled environment.

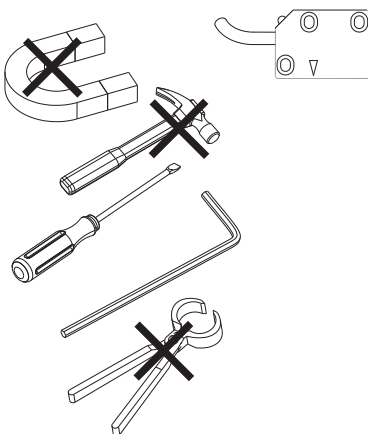

This encoder system is a high performance metrology product and must be handled carefully. The use of industrial tools during installation or exposure to strong magnets such as a magnetic base is not recommended as it carries the risk of damaging parts of the system which as a result might not perform in accordance with specifications.

Packaging

Each readhead is packed individually in antistatic bag, according to ESD protection measures.

Labeling

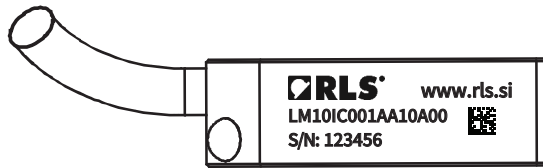

Label on the readhead contains: full PN, 6 digits long serial number and 2D code containing the serial number.

Dimensions

Dimensions and tolerances are in mm. Dimensions without tolerance values are in accordance with ISO 2768-m.

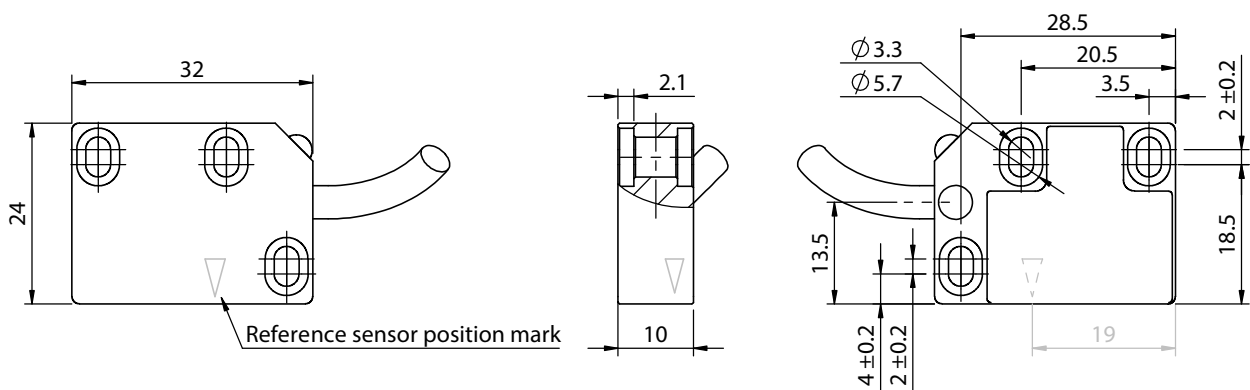

3D model available for download at [RLS Media center](#).

General tolerances for linear dimensions according to ISO 2768 m

Tolerance class	up to 6	6-30	30-120
m (medium)	± 0.1	± 0.2	± 0.3

LM10 readhead with cable with stainless-steel protection tube

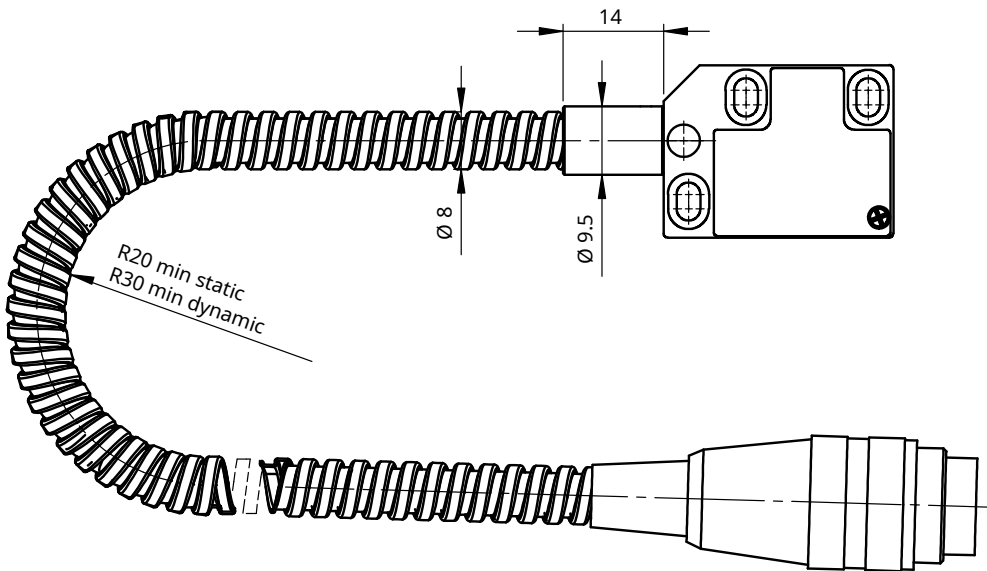

Max. length of cable with flexible stainless-steel conduit is 10 m.

Installation instructions

The readhead LED must be green at all measuring length positions. Otherwise, the installation is not performed correctly. The 0.1 mm to 1.0 mm thick plastic spacer (shim) can be used to facilitate installation. For optimal installation, the recommended thickness of the shim is 0.3 mm. After mounting the magnetic scale, place the plastic shim and the readhead on the magnetic scale. Make sure that the readhead, shim and magnetic scale are in full contact.

Improper mounting of the magnetic scale and readhead can impair the function of the magnetic encoder system and lead to total failure.

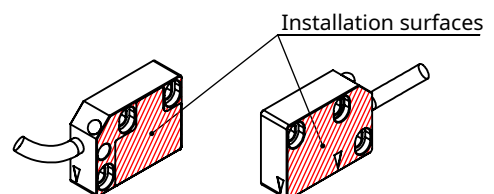

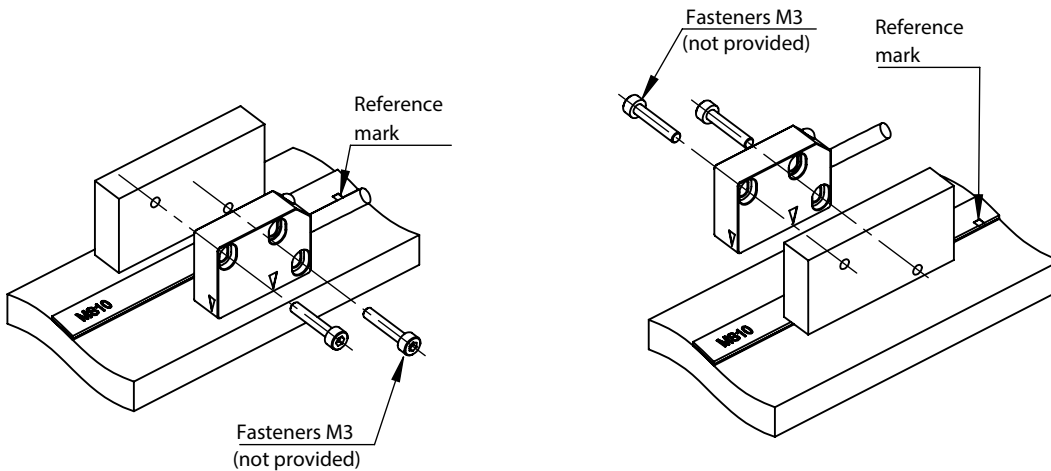

Images are for illustration purposes only. Valid for all versions.

Position of installation holes

Recommended use of M3 fasteners with washers. For more information, see **Table of recommended fastener tightening torques** at **RLS Media center**.

- The magnetic encoder system must be installed and mounted in strict compliance with the dimensions and tolerances given on **page 4**. All permissible distance and angle tolerances must be strictly complied according to the mounting instructions found at MSD01, MR01D01 or MR02D02 data sheet at **RLS Media center**.
- It is important that the space between the readhead and the magnetic scale is maintained over the entire measuring range.
- The magnetic encoder system must be used in accordance with the specified degree of protection. The following factors must be taken into account: IP protection class, operating temperature, external magnetic field, humidity level, mechanical load and EMC compatibility.
- The magnetic encoder system is sensitive to the external magnetic fields. The magnitude of the influence on the magnetic encoder system depends on the magnitude and direction of the external magnetic field. In particular, the rapidly changing stray magnetic fields affect the system and can alter its function. Magnetic field strength within 1 mT reduces the accuracy of the system. Field strengths greater than 1 mT will cause the system to malfunction and as a result the readhead will report an incorrect position with the red color LED. Magnetic field strengths greater than 25 mT will cause irreversible damage to the magnetic scale or ring and will have to be replaced.

Cable installation

Static:

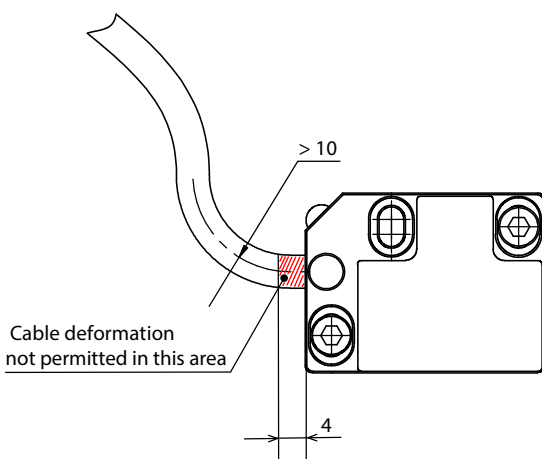

Dynamic:

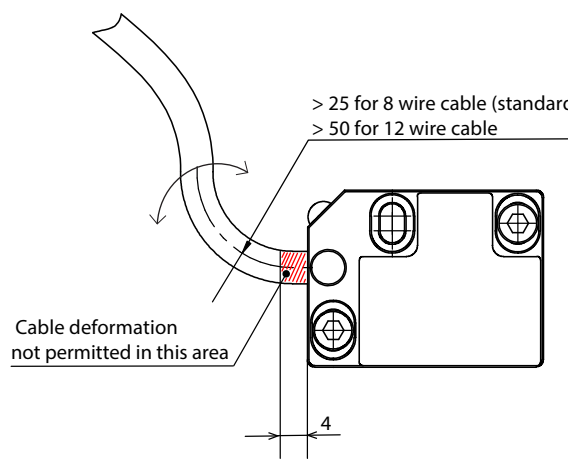

Technical specifications

System data

Pole length		2 mm
Maximum measuring length		50 m (up to 150 m per request)
System accuracy	Linear application	±10 µm/m / ±20 µm/m / ±40 µm/m
	MS magnetic scale	Different accuracy grades of MS magnetic scale are available. Refer to MSD01 available at RLS Media center .
	Rotary application	Axial: Refer to MR01D01 available at RLS Media center . Radial: Refer to MR02D02 available at RLS Media center .
Hysteresis		< 3 µm at 0.3 mm ride height
Repeatability		< 1 µm at 25°C
Reference mark		Unique / Periodic / DCRM (information about distance coded ref. mark can be found in the MSD01 at RLS Media center).
Resolution		Max. 13 bit (~0.244 µm) For details refer to the Table of available resolutions .
Maximum speed	Linear application	Refer to MSD01 available at RLS Media center .
	Rotary application	Axial: Refer to MR01D04 available at RLS Media center . Radial: Refer to speed calculator available at RLS website .

Electrical data

For electrical data see specific output type on pages 12 to 15.

Mechanical data

Mass	Readhead	23 g
Material	Readhead	Die-cast, Zamak-5

Environmental data

Temperature	Operating	-10 °C to +80 °C (-20 °C to +85 °C if cable under non-dynamic conditions)
	Storage	-40 °C to +85 °C
Environmental sealing		IP68 (according to IEC 60529)*
EMC Immunity		IEC 61000-6-2
EMC Emission		IEC 61000-6-4
Vibrations (55 Hz to 2000 Hz)		300 m/s ² (IEC 60068-2-6)
Shocks (6 ms)		300 m/s ² (IEC 60068-2-27)
External magnetic field during operation		1 mT

* Limited by the connector.

Cable

Type	PUR high flexible cable, drag-chain compatible, double-shielded	
Number of wires	8	12**
Outer diameter	4.2 mm ±0.2 mm	4.5 mm ±0.2 mm
Jacket material	Extruded polyurethane (PUR)	
White wire	0.14 mm ² , 26 AWG, 0.13 Ω/m	0.08 mm ² , 28 AWG, 0.23 Ω/m
Other wires	0.05 mm ² , 30 AWG, 0.35 Ω/m	
Durability	20 million cycles at 25 mm bend radius	20 million cycles at 50 mm bend radius
Weight	34 g/m nominal	38 g/m nominal
Bend radius (internal radius)	Dynamic: 25 mm, static: 10 mm	Dynamic: 50 mm, static: 10 mm
Dynamic torsion	Not allowed*	

* Cable is not torsion specified. A continuous torsion of the cable in a dynamic application could result in malfunctioning of the encoder system.

** Applied only for option with additional alarm output (for IA, IC; not available for PRG option).

Cable tolerances

LM10 with cable

Cable length* [m]	Tolerance [mm]
≤ 5	+50/-20
> 5 ≤ 10	+70/-30
> 10 ≤ 30	+100/-40





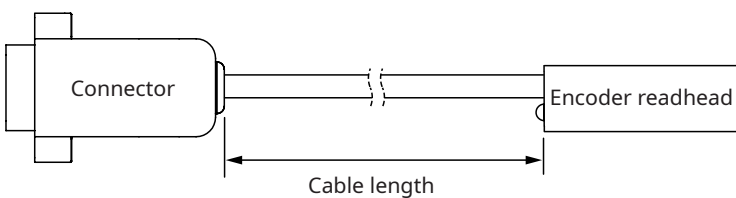

LM10 with cable with stainless-steel protection tube

Cable length* [m]	Tolerance [mm]
≤ 5	+70/-30
> 5 ≤ 10	+100/-40

* Cable length without connector. See image below.

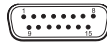

Electrical connections

Function	Signal	Colour (option F)	9 pin D type plug (option A)	15 pin D type plug (option D)	9 pin CPC connector (option E)	15 pin HD type plug (option H)	15 pin D type plug (option L)	9 pin D type plug (option P)	7 pin DIN EN60130-9 plug (option U)
									
Power	Vdd	Brown	5	7	8	7	4	5	5
	GND	White	9	2	7	2	12	1	1
Incremental / analogue signals	A / V ₁	Green	4	14	1	14	9	2	3
	A- / V ₁₋	Yellow	8	6	4	6	1	6	-
	B / V ₂	Blue	3	13	2	13	10	4	4
	B- / V ₂₋	Red	7	5	5	5	2	8	-
Reference signals	Z / V ₀	Pink	2	12	3	12	3	3	6
	Z- / V ₀₋	Grey	6	4	6	4	11	7	-
Alarm*	E	Violet	-	11	-	11	-	-	-
	E-	Black	-	3	-	3	-	-	-
Shield	Inner	-	1	15	7	15	15	9	-
	Outer	-	Case	Case	9	Case	Case	Case	Case

* For alarm output "07" option must be ordered.

Shield connection

Figure below shows a recommended shield termination in order to ensure electromagnetic compatibility.

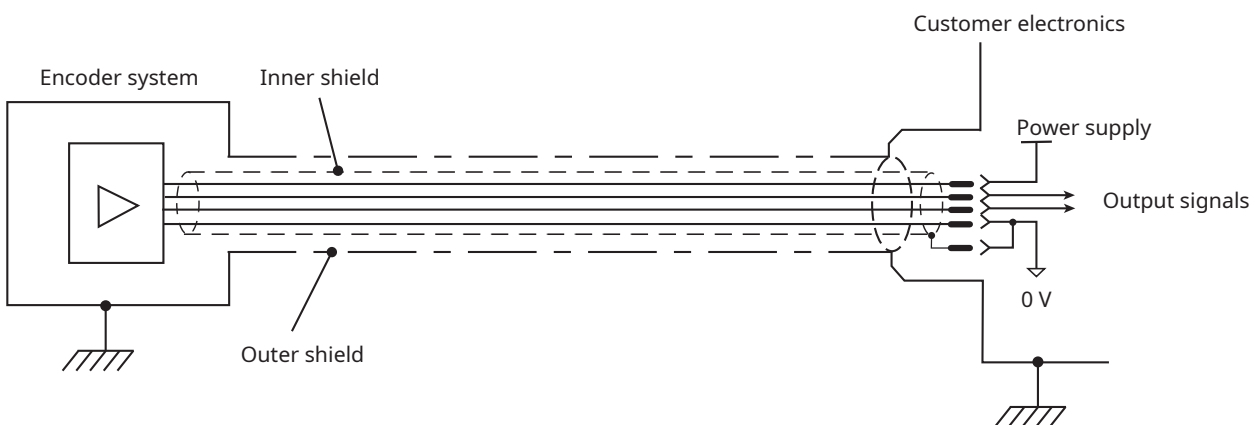

Housing of the encoder is galvanically connected with the housing of the connector via the cable outer shield. The encoder system must be correctly integrated to achieve EMC compliance. In particular, attention to shielding arrangements is essential.

Response time

	LM10AV	LM10IB	LM10IC_02*	LM10IA_02*	LM10IA	LM10IC
Set-up time	10 ms	10 ms	10 ms	10 ms	10 ms	10 ms
Interpolation conversion time	—	<250 ns	<250 ns	<250 ns	<250 ns	<250 ns
Transition time	<10 μ s	<10 μ s	<10 μ s	<10 μ s	<100 ms	<100 ms

*Shortened reaction time option.

Set-up time is the time needed for the encoder readhead to start reading the position information after power-on (see diagram 1).

Interpolation conversion time is the time needed for the encoder readhead to convert the position information into an output signal.

Transition time is the time it takes the encoder readhead to switch from an alarm state to a valid output signal (see diagram 2).

Diagram 1: Set-up time

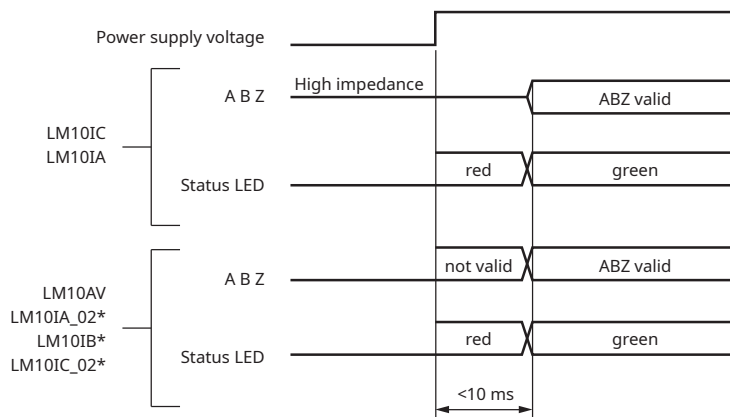

*In alarm state LED flashes red/green.

Diagram 2: Transition time

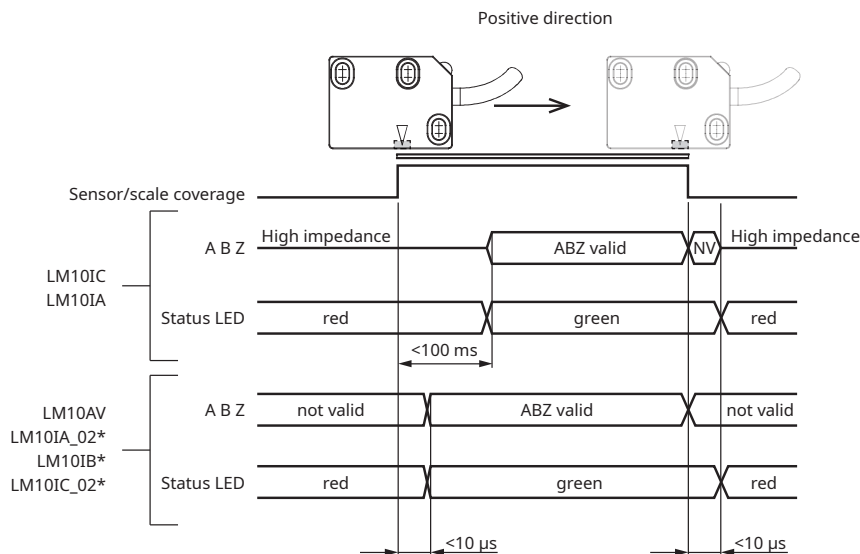

Status indicator LED

After installation of the magnetic scale or ring (for MSD01, MR01D01 or MR02D02 data sheet refer to [RLS Media center](#)), the readhead can be easily adjusted on the machine using the set-up LED indicator.

LED Signal	Status	Error output (special option 07)			
		IC (E)	IC (E-)	IA (E)	IA (E-)
Green	Good signal strength/set-up	$U_L \leq 0.5 \text{ V}$	$U_H \geq 2.5 \text{ V}$	$U_L \leq 1.15 \text{ V}$	$U_H \geq 3.45 \text{ V}$
Red	Poor signal strength. Possible reasons: <ul style="list-style-type: none"> • Incorrect readhead orientation. • Readhead installation out of tolerance. • Demagnetisation of measuring scale. • Insufficient power supply voltage. 	$U_H \geq 2.5 \text{ V}$	$U_L \leq 0.5 \text{ V}$	$U_H \geq 3.45 \text{ V}$	$U_L \leq 1.15 \text{ V}$
Red/green flashing	IB, IC_02, IA_02: poor signal strength Poor signal strength. Possible reasons: <ul style="list-style-type: none"> • Incorrect readhead orientation. • Readhead installation out of tolerance. • Demagnetisation of measuring scale. • Insufficient power supply voltage. 	Not applicable.			

The LED signal functions listed in the table above do not indicate non-optimal installation of the readhead, such as accuracy outside the specified range or improper operation of the reference mark.

Positive direction

Digital output signals – A leads B (magnetic scale is stationary)

Analogue output signals (1 V_{pp}) – V₁ leads V₂

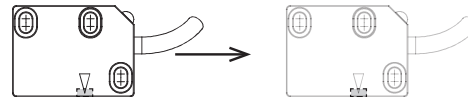

For more information, see the MSD01, MR02D02 or MR01D01 data sheet at [RLS Media center](#).

Output type

Analogue output signals (1 V_{pp})

LM10AV

Specifications

Power supply* (voltage on readhead)	4.7 V to 7 V Reverse polarity protection	
Current consumption	< 50 mA (without load)	
Voltage drop over cable**	~24 mV/m (without load)	
Output signals	V ₁ , V ₂ , V ₀	
Sinusoidal period length	2 mm	
Sine / cosine signals	Amplitude (with 120 Ω termination)	0.6 V _{pp} to 1.2 V _{pp}
	Phase shift	90° ± 0.5°
Reference signal	Amplitude (with 120 Ω termination)	0.8 V _{pp} to 1.2 V _{pp}
	Position	45°
	Width	22.5°
Termination	Z ₀ = 120 Ω between associated outputs	
Maximum cable length*	30 m	

* Please consider voltage drop over cable.

** At added termination expect higher current consumption, which will result in a higher voltage drop over cable.

Timing diagram

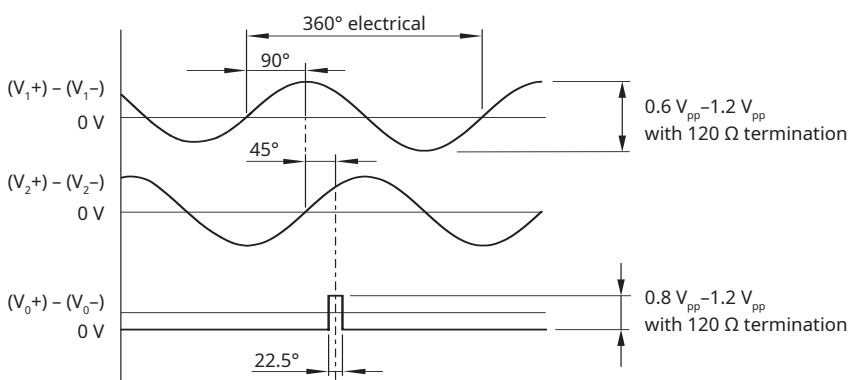

Recommended signal termination

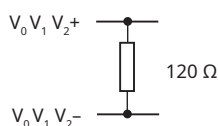

Incremental, Push-Pull output

LM10IA

Specifications

Power supply* (voltage on readhead)	4.7 V to 30 V Without reverse polarity protection
Current consumption	< 35 mA (without load)
Voltage drop over cable**	~17 mV/m (without load)
Output signals	3 square-wave signals A, B, Z and their inverted signals A-, B-, Z-
Reference signal	1 or more square-wave pulse Z and its inverted pulse Z-
Signal level	For 30 V: $U_H \geq 29.2 \text{ V}$ at $-I_H = 30 \text{ mA}$ $U_L \leq 0.5 \text{ V}$ at $I_L = 30 \text{ mA}$ For 5 V: $U_H \geq 4.2 \text{ V}$ at $-I_H = 20 \text{ mA}$ $U_L \leq 0.5 \text{ V}$ at $I_L = 20 \text{ mA}$
Permissible load	$I_L \leq 50 \text{ mA}$ max. load per output Outputs are protected against short circuit to 0 V and to +5 V
Alarm	High impedance on output lines A, B, A-, B- Special option 02: Alarm is not signaled by high impedance state of the A, B, /A, /B signals Special option 07: Alarm signal is output parallel as line driver signal
Switching time - A, B, Z signals (10 to 90 %)	For 24 V: $t_+ = t_- < 380 \text{ ns}$ (typ. 120 ns) For 5 V: $t_+ = t_- < 200 \text{ ns}$ (typ. 42 ns) Measured at $C_{LOAD} = 1000 \text{ pF}$
Maximum cable length*	30 m

* If power supply voltage is <10 V, please consider voltage drop over cable.

** At added termination expect higher current consumption, which will result in a higher voltage drop over cable.

Timing diagram

Complementary signals are not shown

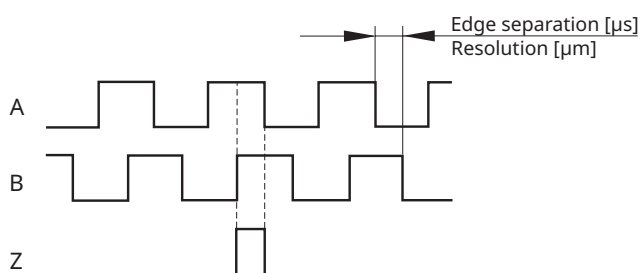

Recommended signal termination

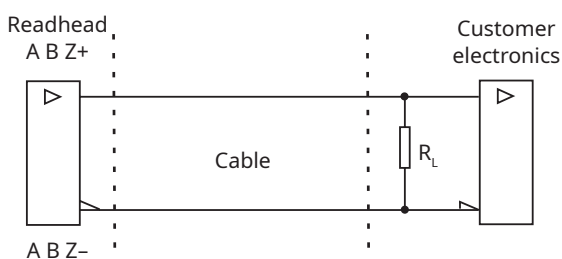

V_{supply}	R_L	I_{load}
5 V	250 Ω	20 mA
30 V	1 k Ω	30 mA

Incremental, Open Collector NPN

LM10IB

Specifications

Power supply	5 V to 30 V Without reverse polarity protection
Current consumption	< 35 mA (without load)
Voltage drop over cable*	~17 mV/m (without load)
Output signals	A, B, Z
Reference signal	1 or more square-wave pulses Z
Maximum load	10 mA
Maximum cable length	See table below

* At added termination expect higher current consumption, which will result in a higher voltage drop over cable.

Edge separation [μm]	Maximum cable length [m]			
0.07	0.2	0.3	1	1.5
0.12	3	2.5	1	1
0.5	10	7	4	3
1	10	10	9	6
2, 4, 5, 10, 20	10	10	10	10
Power supply voltage [V]	5	12	24	30
R_L [Ω]*	500	1200	2400	3000

Encoder cable length and all other cable extensions should be taken into account.

*Recommended values. For higher values of R_L shorter cables should be used.

Timing diagram

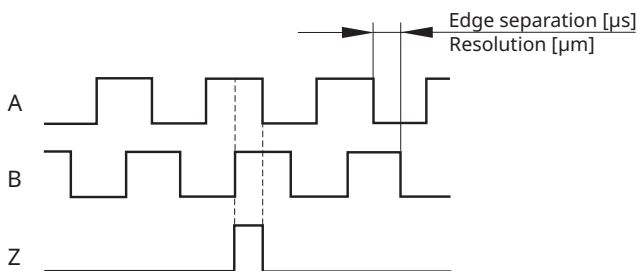

Recommended signal termination

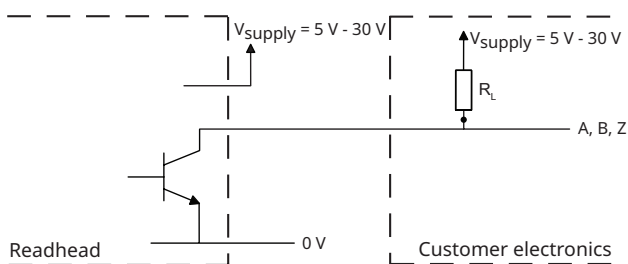

Incremental, RS422

LM10IC

Specifications

Power supply* (voltage on readhead)	4.7 V to 7 V Reverse polarity protection
Current consumption	< 35 mA (without load)
Voltage drop over cable**	~17 mV/m (without load)
Output signals	3 square-wave signals A, B, Z and their inverted signals A-, B-, Z-
Reference signal	1 or more square-wave pulse Z and its inverted pulse Z-
Signal level	Differential line driver according to EIA standard RS422: $U_H \geq 2.5 \text{ V}$ at $-I_H = 20 \text{ mA}$ $U_L \leq 0.5 \text{ V}$ at $I_L = 20 \text{ mA}$
Permissible load	$Z_0 \geq 100 \Omega$ between associated outputs $I_L \leq 20 \text{ mA}$ max. load per output Capacitive load $\leq 1000 \text{ pF}$ Outputs are protected against short circuit to 0 V and to +5 V Only one output shorted at a time
Alarm	High impedance on output lines A, B, A-, B- Special option 02: Alarm is not signaled by high impedance state of the A, B, /A, /B signals*** Special option 07: Alarm signal is output parallel as line driver signal
Switching time - A, B, Z signals (10 to 90 %)	$t_+, t_- < 30 \text{ ns}$ (with 1 m cable and recommended input circuit)
Maximum cable length*	30 m

* Please consider voltage drop over cable.

** At added termination expect higher current consumption, which will result in a higher voltage drop over cable.

*** See diagrams 1 and 2 on [page 10](#)

Timing diagram

Complementary signals not shown

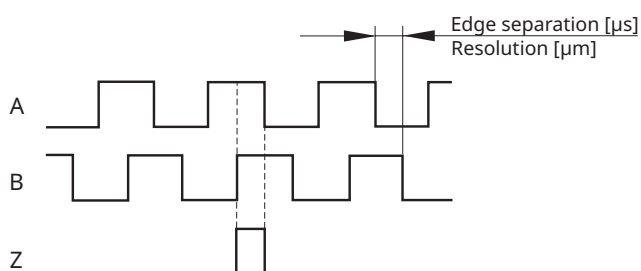

Recommended signal termination

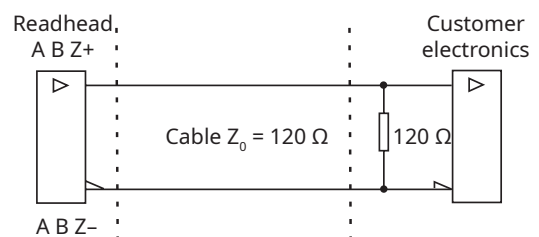

Programming (for IC output only)

Readheads can be ordered preset to the required resolution or supplied so they can be programmed on the machine to the selected resolution. This programming is done by connecting the readhead to a computer via a programming interface **UPRG01**. The readhead must be ordered with the PRG option to use this function. For more information on the programming function of the LM10 readhead, see [UPRG01 Programming interface website](#).

Part numbering

LM10 IC 010 C A 10 F 00

Output type

- AV** - Analogue voltage $1 V_{pp}$
- IA** - Incremental Push-Pull outputs
- IB** - Incremental, Open Collector NPN
- IC** - Incremental, RS422

Interpolation factor

AV:

000 - N/A

IA, IB and IC:

13B - 8192 (0.244 μm)	09B - 512 (3.906 μm)	020 - 100 (20 μm)
12B - 4096 (0.488 μm)	D50 - 500 (4 μm)	D08 - 80 (25 μm)
11B - 2048 (0.977 μm)	005 - 400 (5 μm)	06B - 64 (31.250 μm)
001 - 2000 (1 μm)	D32 - 320 (6.250 μm)	050 - 40 (50 μm)
1D6 - 1600 (1.250 μm)	08B - 256 (7.813 μm)	05B - 32 (62.500 μm)
10B - 1024 (1.953 μm)	010 - 200 (10 μm)	04B - 16 (125 μm)
002 - 1000 (2 μm)	D16 - 160 (12.500 μm)	03B - 8 (250 μm)
D80 - 800 (2.500 μm)	07B - 128 (15.625 μm)	

PRG - Programmable (preset to 1 μm)

For DPI resolution see [Table of available resolutions](#).

Minimum edge separation

IA, IB and IC:

K - 0.07 μs (15 MHz)	E - 4 μs (0.25 MHz)
A - 0.12 μs (8 MHz)	F - 5 μs (0.2 MHz)
B - 0.5 μs (2 MHz)	G - 10 μs (0.1 MHz)
C - 1 μs (1 MHz)	H - 20 μs (0.05 MHz)
D - 2 μs (0.5 MHz)	

AV:

A - N/A

The customer's controller must support the selected edge separation time even if the encoder is used below the maximum speed.

Reference mark sensor

- A** - With reference mark sensor
Magnetic scale or ring must be ordered with reference mark. If required, the cover foil can be installed over the magnetic scale.
- B** - Without reference mark sensor
- C** - Without reference mark sensor but with periodic reference impulse as per scale pitch (every 2 mm)
Reference periods correspond to pole length of magnetisation. Magnetic scale or ring must be ordered with no reference mark.

Cable length

- 10** - 1.0 m (standard)
(e.g. 13 - 1.3 m cable or 13 - 13 m cable if special option **0M** is chosen)

Connector

- | | |
|--------------------------------------|-------------------------------------|
| A - 9 pin D type plug | H - 15 pin HD type plug |
| D - 15 pin D type plug | L - 15 pin D type plug |
| E - 9 pin CPC connector | P - 9 pin D type plug |
| F - Flying lead, no connector | U - 7 pin DIN EN60130-9 plug |

Special requirements

- | | |
|--|---|
| 00 - No special requirements (standard) | 19 - Stainless steel housing |
| 02 - Shortened reaction time | 40 - Protective stainless-steel tube for cable |
| 05 - For DPI resolution | 0M - Cable length in meters |
| 07 - Additional alarm output | 4M - Protective stainless-steel tube and cable in meters |
| 10 - Not potted, protected to IP50 | 72 - Additional alarm output and shortened response time |

Not all part number combinations are valid. Please refer to the table of available combinations on the next page for available options.

Table of available combinations

Series	Output type	Interpolation factor	Minimum edge separation	Reference mark	Cable length	Connector	Special requirements
LM10	IC	PRG**	A	A/B/C	10***	A**/D/E/H /F/U**	00/02/05/07 /10/19/40/ 0M/4M
		xxx*	K/A/B/C/D/E/ F/G/H				
		04B	A/B/C/D/E/F /G/H	B/C			
		03B	B/C/D/E/F/ G/H				
	IA	xxx*	K/A/B/C/D/E/ F/G/H	A/B/C			
		04B	A/B/C/D/E/F /G/H	B/C			
		03B	B/C/D/E/F/ G/H				
	IB	xxx*	K/A/B/C/D/E/ F/G/H	A/B/C			
		04B	A/B/C/D/E/F /G/H	B/C			
		03B	B/C/D/E/F/ G/H				
	AV	000	A	A/B/C		A/L/P/F	

* See chapter **Available resolutions** for available interpolation factors.

** Not available with special option 07.

*** See the Output Type section for the max cable length for each output type.

For the part numbering of the MS incremental magnetic scale or the MR radial and axial incremental magnetic ring, refer to the data sheets **MSD01**, **MR02D02** and **MR01D01** at **RLS Media center**.

Available resolutions

Table of available resolutions

Part number	Interpolation factor	Resolution		
		In μm with 2 mm poles	CPI (counts per inch 2,032 mm) ¹⁾	DPI (pulse per inch 2,032 mm) ²⁾
13B	2 ¹³	0.244140625	102,400	25,600
12B	2 ¹²	0.48828125	51,200	12,800
11B	2 ¹¹	0.9765625	25,600	6,400
001	2000	1	25,000	6,250
1D6	1600	1.25	20,000	5,000
10B	2 ¹⁰	1.953125	12,800	3,200
002	1000	2	12,500	3,125
D80	800	2.5	10,000	2,500
09B	2 ⁹	3.90625	6,400	1,600
D50	500	4	6,250	1,562.5
005	400	5	5,000	1,250
D32	320	6.25	4,000	1,000
08B	2 ⁸	7.8125	3,200	800
010	200	10	2,500	625
D16	160	12.5	2,000	500
07B	2 ⁷	15.625	1,600	400
020	100	20	1,250	312.5
D08	80	25	1,000	250
06B	2 ⁶	31.25	800	200
050	40	50	500	125
05B	2 ⁵	62.5	400	100
04B	2 ⁴	125	200	50
03B	2 ³	250	100	25

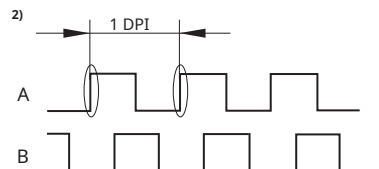
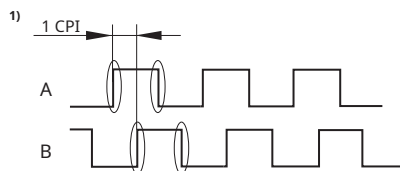

Resolutions calculation

$$\text{Resolution } [\mu\text{m}] = \frac{\text{Pole length } [\mu\text{m}]}{\text{Interpolation factor}} = \frac{2000}{\text{Interpolation factor}}$$

For ring applications:

CPR – Counts per revolution (resolution)

$$\text{Resolution [CPR]} = \text{Pole number} * \text{Interpolation factor}$$

PPR – Pulses per revolution

$$\text{Resolution [PPR]} = \frac{\text{Resolution [CPR]}}{4}$$

Resolutions calculation for CPI/DPI

$$\text{Resolution } [\mu\text{m}] = \frac{\text{Pole length } [\mu\text{m}]}{\text{Interpolation factor}} = \frac{2032}{\text{Interpolation factor}}$$

$$\begin{aligned} \text{Resolution [CPI]} &= \frac{\text{Inch } [\mu\text{m}]}{\text{Resolution } [\mu\text{m}]} = \\ &= \frac{\text{Inch } [\mu\text{m}] \times \text{Interpolation factor}}{\text{Pole length } [\mu\text{m}]} = \\ &= \frac{25400 \times \text{Interpolation factor}}{2032} \end{aligned}$$

$$\text{Resolution [DPI]} = \frac{\text{CPI}}{4}$$

*See pole numbers in the MR01D01 or MR02D02 data sheet at **RLS Media center**.

Accessories



USB encoder interface
E201-9Q

(Compatible only with LM10IC)



Programmable interface
UPRG01

(Compatible only with LM10IC)

Head office

RLS Merilna tehnika d. o. o.

Poslovna cona Žeje pri Komendi
Pod vrbami 2
SI-1218 Komenda
Slovenia

T +386 1 5272100
E mail@rls.si

www.rls.si

Global support

Visit our [website](#) to contact your nearest sales representative.

Document issues

Date	Issue	Page	Description
13. 10. 2022	16	General	New design, data amended
		8	Cable length drawing added
20. 4. 2023	17	9	Electrical connections data amended
		12-15	Current consumption and voltage drop over cable data amended

This product is not designed or intended for use outside the environmental limitations and operating parameters expressly stated on the product's datasheet. Products are not designed or intended for use in medical, military, aerospace, automotive or oil & gas applications or any safety-critical applications where a failure of the product could cause severe environmental or property damage, personal injury or death. Any use in such applications must be specifically agreed to by seller in writing, and is subject to such additional terms as the seller may impose in its sole discretion. Use of products in such applications is at buyer's own risk, and buyer will indemnify and hold harmless seller and its affiliates against any liability, loss, damage or expense arising from such use. Information contained in this datasheet was derived from product testing under controlled laboratory conditions and data reported thereon is subject to the stated tolerances and variations, or if none are stated, then to tolerances and variations consistent with usual trade practices and testing methods. The product's performance outside of laboratory conditions, including when one or more operating parameters is at its maximum range, may not conform to the product's datasheet. Further, information in the product's datasheet does not reflect the performance of the product in any application, end-use or operating environment buyer or its customer may put the product to. Seller and its affiliates make no recommendation, warranty or representation as to the suitability of the product for buyer's application, use, end-product, process or combination with any other product or as to any results buyer or its customer might obtain in their use of the product. Buyer should use its own knowledge, judgment, expertise and testing in selecting the product for buyer's application, end-use and/or operating environment, and should not rely on any oral or written statement, representation, or samples made by seller or its affiliates for any purpose. EXCEPT FOR THE WARRANTIES EXPRESSLY SET FORTH IN THE SELLER'S TERMS AND CONDITIONS OF SALE, SELLER MAKES NO WARRANTY EXPRESS OR IMPLIED WITH RESPECT TO THE PRODUCT, INCLUDING ANY WARRANTY OF MERCHANTABILITY OR FITNESS FOR ANY PARTICULAR PURPOSE, WHICH ARE DISCLAIMED AND EXCLUDED. All sales are subject to seller's exclusive terms and conditions of sale which, where the seller is (a) RLS Merilna tehnika d. o. o., are available at <https://www.rls.si/eng/salesterms>, (b) Renishaw, Inc., are available at <https://www.renishaw.com/legal/en/-/42186>, or (c) another person, are available on request, and in each case, are incorporated herein by reference, and are the exclusive terms of sale. No other terms and conditions apply. Buyer is not authorized to make any statements or representations that expand upon or extend the environmental limitations and operating parameters of the products, or which imply permitted usage outside of that expressly stated on the datasheet or agreed to in writing by seller.

RLS Merilna tehnika d. o. o. has made considerable effort to ensure the content of this document is correct at the date of publication but makes no warranties or representations regarding the content. RLS Merilna tehnika d. o. o. excludes liability, howsoever arising, for any inaccuracies in this document. © 2023 RLS d. o. o.