

# RESOLUTE™ Functional Safety absolute optical encoder system



**RESOLUTE™ Functional Safety (FS) is a true-absolute fine-pitch optical encoder system offering an impressive specification that is certified to Functional Safety standards.**

Patented RESOLUTE encoder technology combines 1 nm resolution with exceptionally high speed, reading from a range of high-accuracy linear tape and spar scales or angle encoder rings.

RESOLUTE encoder systems use a single optical absolute track with a nominal pitch of 30 µm, combined with sophisticated optics. This ensures wide set-up tolerances, very low sub-divisional error and ultra-low noise (jitter), resulting in better velocity control performance and rock solid positional stability.

RESOLUTE FS encoders are for use in Functional Safety applications being certified to ISO 13849 Category 3 PLd, IEC 61508 SIL2 and IEC 61800-5-2 SIL2.

- True-absolute non-contact optical encoder system: no batteries required
- ISO 13849 Category 3 PLd
- IEC 61508 SIL2
- IEC 61800-5-2 SIL2
- Wide set-up tolerances for quick and easy installation
- Resolutions to 1 nm linear or 32 bit rotary
- IP64 sealed readhead for high reliability in harsh environments
- Integral set-up LED enables easy installation and provides diagnostics at a glance
- Operates up to 80 °C with an integral over-temperature alarm
- Compatible with a wide range of linear and rotary scales
- Available with BiSS Safety and Siemens DRIVE-CLiQ serial interfaces

## System features

### Unique single-track absolute optical scale

- Absolute position is determined immediately upon switch-on
- No battery back-up
- No yaw de-phasing unlike multiple-track systems
- Fine pitch (30 µm nominal period) optical scale for superior motion control compared to inductive, magnetic or other non-contact optical absolute encoders
- High-accuracy graduations marked directly onto tough engineering materials for outstanding metrology and reliability

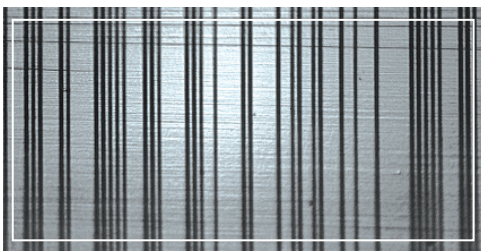

### High dirt immunity

- Advanced optics and embedded surplus code means the RESOLUTE encoder system even reads dirty scale
- Absolute position can be determined in all three cases shown here; clean scale (left), grease contamination (below-left), particle contamination (below)

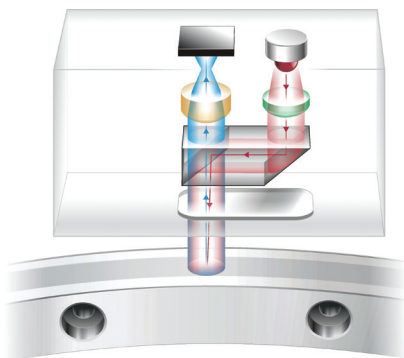
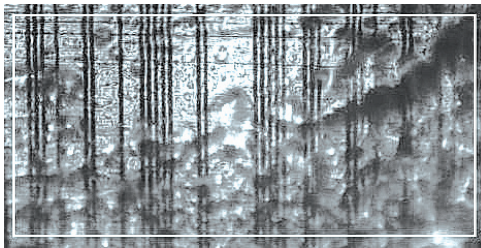

### Unique detection method

- Readhead acts like an ultra-fast miniature digital camera, taking photos of a coded scale
- Photos are analysed by a high-speed digital signal processor (DSP) to determine absolute position
- Built-in position-check algorithm constantly monitors calculations for ultimate safety and reliability
- Advanced optics and position determination algorithms are designed to provide low noise (jitter < 10 nm RMS) and low sub-divisional error (SDE ±40 nm)

## Optional Advanced Diagnostic Tool

The RESOLUTE encoder system is compatible with the Advanced Diagnostic Tool ADTa-100<sup>1</sup> and ADT View software, which acquire detailed real-time data from the readhead to allow easy set-up, optimisation and in-field fault finding.



The intuitive software interface provides:

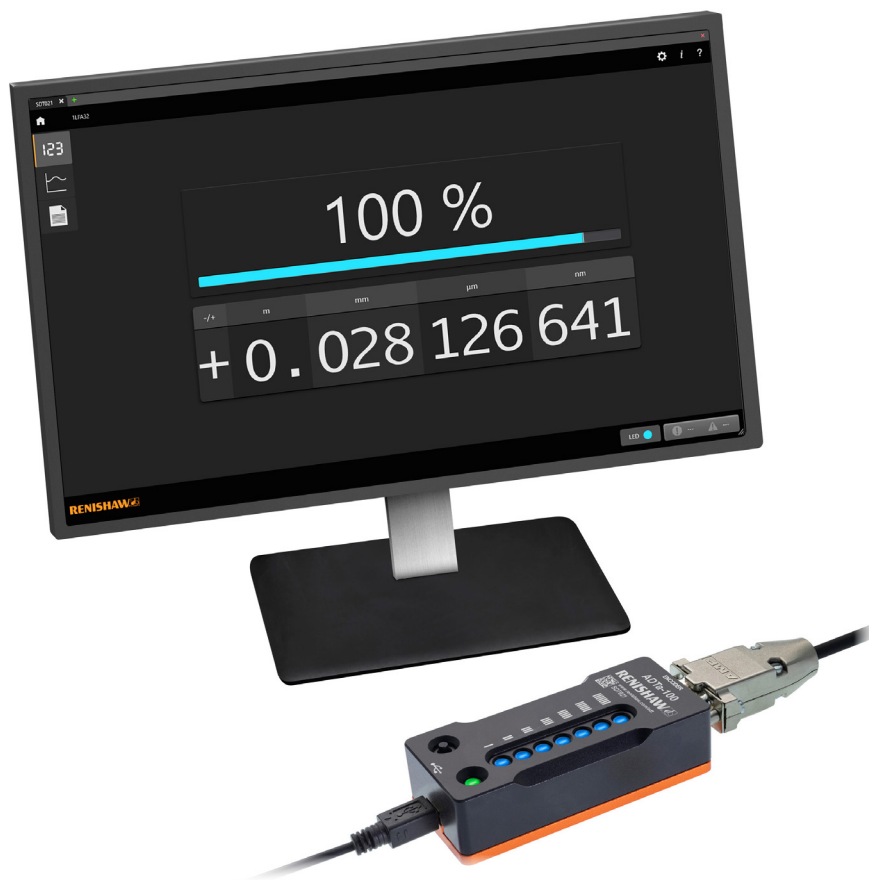

- Digital readout of encoder position and signal strength
- Graph of signal strength over the entire axis travel
- System configuration information



<sup>1</sup> ADTa-100 compatible readheads are marked with the symbol **ADT**

## Compatible linear scales

	<b>RTLA30-S<sup>1</sup></b> Self-adhesive mounted stainless steel tape scale	<b>RTLA30 (with <i>FASTRACK</i>™ carrier)</b> Stainless steel tape scale and self-adhesive mounted carrier
		
<b>Form (height x width)</b>	0.4 mm x 8 mm including adhesive	RTLA30 scale: 0.2 mm x 8 mm <i>FASTRACK</i> carrier: 0.4 mm x 18 mm including adhesive
<b>Accuracy (at 20 °C)</b>	±5 µm/m	±5 µm/m
<b>Maximum length<sup>2</sup></b>	21 m	RTLA30 lengths up to 21 m <i>FASTRACK</i> carrier lengths up to 25 m
<b>Coefficient of thermal expansion (at 20 °C)</b>	10.1 ±0.2 µm/m/°C	10.1 ±0.2 µm/m/°C



	<b>RELA30</b> Self-adhesive mounted low-expansion ZeroMet™ spar scale	<b>RSLA30</b> Self-adhesive mounted stainless steel spar scale
		
<b>Form (height x width)</b>	1.5 mm x 14.9 mm	1.6 mm x 14.9 mm
<b>Accuracy (at 20 °C)</b>	Up to 1 m : ±1 µm 1 m to 1.5 m : ±1 µm/m	Up to 1 m : ±1.5 µm 1 m to 2 m : ±2.25 µm 2 m to 3 m : ±3 µm 3 m to 5 m : ±4 µm
<b>Maximum length<sup>2</sup></b>	1.5 m	5 m
<b>Coefficient of thermal expansion (at 20 °C)</b>	0.75 ±0.35 µm/m/°C	10.1 ±0.2 µm/m/°C

<sup>1</sup> For RTLA30-S axis lengths > 2 m, the *FASTRACK* carrier with RTLA30 is recommended.

<sup>2</sup> The maximum scale length may be limited for some serial interfaces and resolutions; refer to '[Linear encoder system](#)' on page 6 for details.

For more information about the linear scales refer to the relevant absolute scale data sheet which can be downloaded from [www.renishaw.com/resolutedownloads](http://www.renishaw.com/resolutedownloads).

## Compatible rotary scales

	<b>RESA30</b>	<b>REXA30</b>
	<b>303/304 stainless steel ring</b>	<b>Ultra-high accuracy 303/304 stainless steel ring</b>
		
<b>Accuracy (at 20 °C)</b>	±1.9 arc second (Typical installed accuracy for a 550 mm diameter ring) <sup>1</sup>	±1 arc second <sup>2</sup> (Total installed accuracy for ring diameters ≥ 100 mm)
<b>Ring diameters</b>	52 mm to 550 mm	52 mm to 417 mm
<b>Coefficient of thermal expansion (at 20 °C)</b>	15.5 ±0.5 µm/m/°C	15.5 ±0.5 µm/m/°C

<sup>1</sup> 'Typical' installations are a result of graduation and installation errors combining and, to some magnitude, cancelling.

<sup>2</sup> Accuracy when using two RESOLUTE readheads. For the accuracy value of ring diameters < 100 mm, see *REXA30 ultra-high accuracy absolute angle encoder* data sheet (Renishaw part no. L-9517-9405).

For more information about the rotary scales refer to the relevant absolute scale data sheet which can be downloaded from [www.renishaw.com/resolutedownloads](http://www.renishaw.com/resolutedownloads).

## Linear encoder system

### Scale lengths and speed

The maximum scale length depends upon the serial interface, readhead resolution and the number of position bits.

The table shows the maximum scale length and speed for each system:

Serial interfaces	Position bits	Resolution		Maximum reading speed
		1 nm	50 nm	
BiSS Safety	28 bit	-	13.42 m	100 m/s
	36 bit	21 m	-	
Siemens DRIVE-CLiQ	28 bit	-	13.42 m	100 m/s
	34 bit	17.18 m	-	

# Angle encoder system

## Resolution

RESOLUTE encoders are available with a variety of resolutions dependent upon the serial interface being used.

All ring sizes are available for all serial interfaces and resolutions.

Serial interfaces	Resolution	Counts per revolution	Arc second
BiSS Safety	32 bit	4 294 967 296	≈ 0.0003
Siemens DRIVE-CLiQ	26 bit	67 108 864	≈ 0.019
	29 bit	536 870 912	≈ 0.0024

**NOTE:** 32 bit resolution is below the noise floor of the RESOLUTE encoder.

## Accuracy

The table below shows the typical installed accuracy for RESOLUTE readheads with standard diameter RESA30 rings.

RESA30 diameter (mm)	Typical installed accuracy <sup>1</sup> (arc second)	RESA30 diameter (mm)	Typical installed accuracy <sup>1</sup> (arc second)
52	±12.7	200	±4.3
57	±11.8	206	±4.2
75	±9.5	209	±4.2
100	±7.5	229	±3.9
101	±7.5	255	±3.6
103	±7.4	280	±3.4
104	±7.3	300	±3.1
115	±6.8	330	±2.9
124	±6.3	350	±2.8
150	±5.5	413	±2.4
165	±7.0	417	±2.4
172	±5.0	489	±2.1
183	±4.7	550	±1.9

For REXA30 accuracy figures, refer to the *REXA30 ultra-high accuracy absolute angle encoder data sheet* (Renishaw part no. L-9517-9405).

## Speed

The maximum speed of the RESOLUTE FS encoder system depends on the mounting method and the scale type.

For further information, refer to the *RESOLUTE™ Functional Safety installation guide and safety manual BiSS Safety encoder system* (Renishaw part no. M-9755-9109) or the *RESOLUTE™ Functional Safety installation guide and safety manual Siemens DRIVE-CLiQ encoder system* (Renishaw part no. M-9796-9134). These documents are available at [www.renishaw.com/fsencoders](http://www.renishaw.com/fsencoders).

<sup>1</sup> 'Typical' installations are a result of graduation and installation errors combining and, to some magnitude, cancelling.

## General specifications

		BiSS Safety	Siemens DRIVE-CLiQ
<b>Power supply</b>		5 V ±10% 1.25 W maximum (250 mA @ 5 V) <sup>1</sup> Ripple: 200 mVpp maximum @ frequency up to 500 kHz maximum	Voltage and current 4.3 W maximum  24 V power is provided by the DRIVE-CLiQ network Interface over voltage protection -36 to +36 V
<b>Temperature</b>	Storage Installation Operating	-20 °C to 80 °C +20 °C ±5 °C 0 °C to +80 °C	-20 °C to 70 °C +20 °C ±5 °C 0 °C to +80 °C (readhead) 0 °C to +55 °C (interface)
<b>Humidity</b>		95% relative humidity (non-condensing) to IEC 60068-2-78	
<b>Sealing</b>		IP64	IP64 (readhead) IP67 (interface)
<b>Environmental protection</b>		Protection class III Pollution degree II Altitude 2000 m	
<b>Acceleration</b>	Operating	500 m/s <sup>2</sup> , 3 axes (readhead only)	
<b>Maximum acceleration of scale with respect to readhead <sup>2</sup></b>		2000 m/s <sup>2</sup>	
<b>Vibration</b>	Operating	300 m/s <sup>2</sup> , 55 Hz to 2000 Hz, 3 axes	300 m/s <sup>2</sup> , 55 Hz to 2000 Hz, 3 axes (readhead) 100 m/s <sup>2</sup> , 55 Hz to 2000 Hz, 3 axes (interface)
<b>Shock</b>	Non-operating	1000 m/s <sup>2</sup> , 6 ms, ½ sine, 3 axes	500 m/s <sup>2</sup> , 11 ms, ½ sine, 3 axes
<b>Mass</b>	Readhead Readhead cable Interface	18 g 32 g/m -	18 g 32 g/m 218 g
<b>EMC compliance</b>		IEC 61800-5-2 Annex E	
<b>Readhead cable</b>		7 core, tinned and annealed copper, 28 AWG Single-shielded, outside diameter 4.7 ±0.2 mm Flex life > 40 × 10 <sup>6</sup> cycles at 20 mm bend radius  UL recognised component 	
<b>Maximum readhead cable length</b>		10 m	10 m (to controller or interface) (refer to Siemens DRIVE-CLiQ specifications for maximum cable length from interface to controller)

**CAUTION:** The RESOLUTE encoder system has been designed to meet the requirements of IEC 61800-5-2: Annex E second environment, but must be correctly integrated to achieve EMC compliance. In particular, attention to shielding arrangements is essential.

<sup>1</sup> Current consumption figures refer to a terminated RESOLUTE BiSS safety system. BiSS Safety encoder systems must be powered from a 5 Vdc supply complying with the requirements for PELV of standard IEC 60950-1.

<sup>2</sup> This is the worst case figure that is correct for the slowest communications clock rates. For faster clock rates, the maximum acceleration of scale with respect to the readhead can be higher. For more details, contact your local Renishaw representative.



## Safety sub-functions

The RESOLUTE Functional Safety BiSS Safety encoder and Siemens DRIVE-CLiQ encoder systems provide safe position data that supports the following safety sub-functions defined by IEC 61800-5-2:2016:

- Safe stop 1 (SS1) and Safe stop 2 (SS2)
- Safe operating stop (SOS)
- Safe limited acceleration (SLA)  $\leq 500 \text{ m/s}^2$
- Safe acceleration range (SAR)  $\leq 500 \text{ m/s}^2$
- Safe limited speed (SLS) <sup>1</sup>  $\leq 100 \text{ m/s}$
- Safe speed range (SSR) <sup>1</sup>  $\leq 100 \text{ m/s}$
- Safely limited position (SLP)
- Safely limited increment (SLI)
- Safe direction (SDI)
- Safe speed monitor (SSM) <sup>1</sup>  $\leq 100 \text{ m/s}$

The system must be installed and operated in accordance with the instructions defined by the installation guide. Failure to follow the correct use instructions and failure to heed the limitations may result in PLd and / or SIL2 not being achieved and will invalidate the functional safety certification.

---

**NOTE:** For the maximum permitted speeds for the range of ring diameters refer to the installation guides. These are available at [www.renishaw.com/fsencoders](http://www.renishaw.com/fsencoders).

---

<sup>1</sup> For further details see the *RESOLUTE™ Functional Safety installation guide and safety manual BiSS Safety encoder system* (Renishaw part no. M-9755-9109) or the *RESOLUTE™ Functional Safety installation guide and safety manual Siemens DRIVE-CLiQ encoder system* (Renishaw part no. L-9796-9134). These documents are available at [www.renishaw.com/fsencoders](http://www.renishaw.com/fsencoders).

## Functional Safety data declaration

### IEC 61508 safety data

	RESOLUTE™ Functional Safety with BiSS® Safety encoder system	RESOLUTE™ Functional Safety Siemens DRIVE-CLiQ encoder system	
		Single readhead systems	Dual readhead systems
Safety Integrity Level	2		
Random Hardware Failures (per hour)	$\lambda_s = 5.94 \times 10^{-7}$ $\lambda_D = 8.80 \times 10^{-7}$ $\lambda_{DD} = 7.92 \times 10^{-7}$ $\lambda_{DU} = 8.80 \times 10^{-8}$	$\lambda_s = 6.86 \times 10^{-7}$ $\lambda_D = 1.07 \times 10^{-6}$ $\lambda_{DD} = 9.64 \times 10^{-7}$ $\lambda_{DU} = 1.07 \times 10^{-7}$	$\lambda_s = 1.26 \times 10^{-6}$ $\lambda_D = 1.95 \times 10^{-6}$ $\lambda_{DD} = 1.76 \times 10^{-6}$ $\lambda_{DU} = 1.96 \times 10^{-7}$
PFD <sub>avg</sub>	Not applicable due to continuous demand mode		
PFH (per hour)	$\lambda_{DU} = 8.80 \times 10^{-8}$	$\lambda_{DU} = 1.07 \times 10^{-7}$	$\lambda_{DU} = 1.95 \times 10^{-7}$
Architectural Constraints	Type B HFT = 0 SFF = 94%		
Hardware safety integrity compliance	Route 1H		
Systematic safety integrity compliance	Route 1S		
Systematic capability	SC2		
Demand mode	Continuous		
Proof test interval	Not required for continuous demand mode		

### ISO 13849 safety data

	RESOLUTE™ Functional Safety with BiSS® Safety encoder system	RESOLUTE™ Functional Safety Siemens DRIVE-CLiQ encoder system	
		Single readhead systems	Dual readhead systems
MTTF <sub>D</sub> (years)	130	106	58
Diagnostic coverage	Medium (90%)		
Category	3		
Performance level	d		
Lifetime/Replacement limits	20 years		

# RESOLUTE FS readhead installation drawing

Dimensions and tolerances in mm

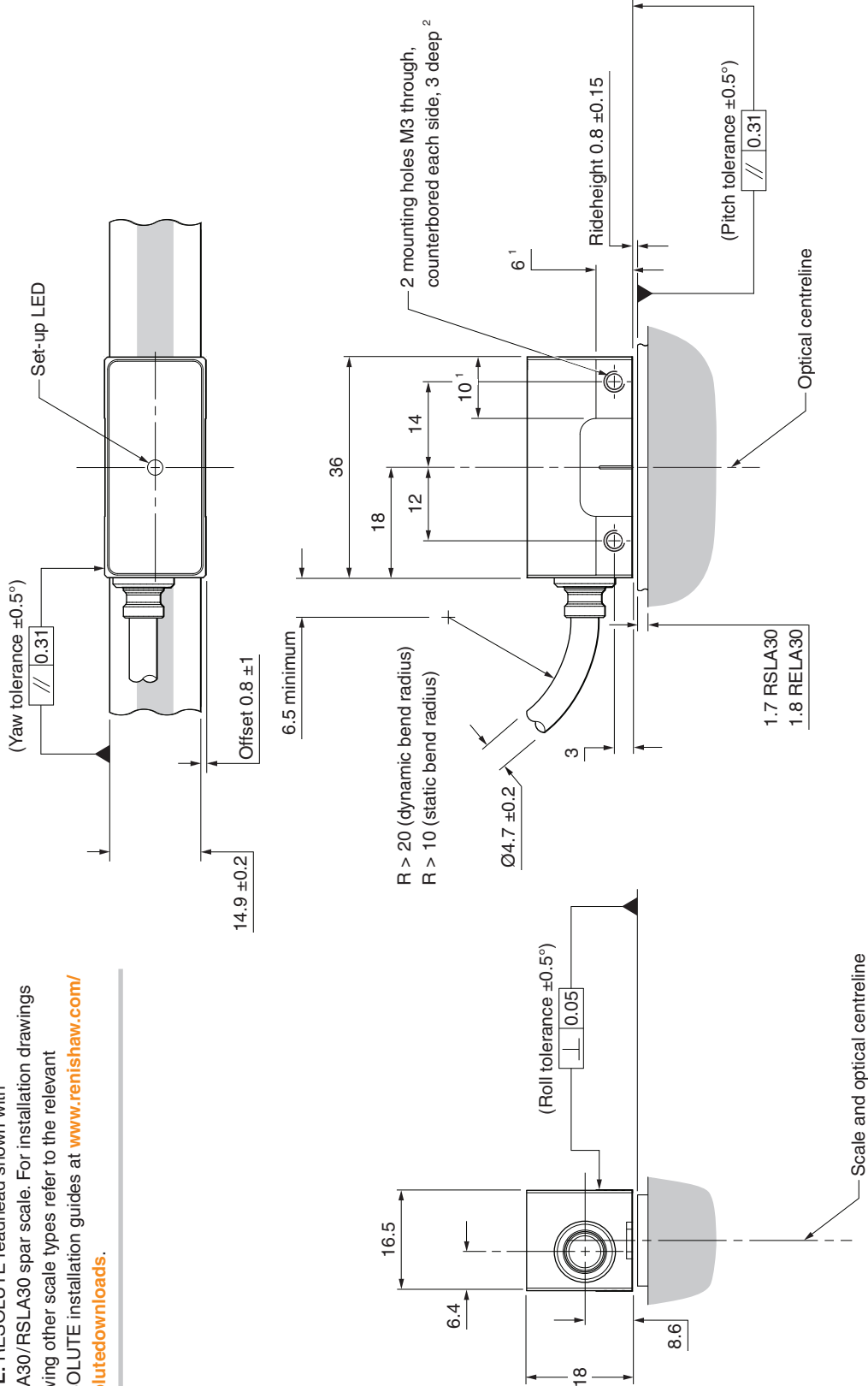

<sup>1</sup> Extent of mounting faces.

<sup>2</sup> The recommended thread engagement is 6 mm minimum (9 mm including counterbore) and the recommended tightening torque is 0.9 Nm to 1.1 Nm.

# RESOLUTE FS side exit cable readhead installation drawing

Dimensions and tolerances in mm

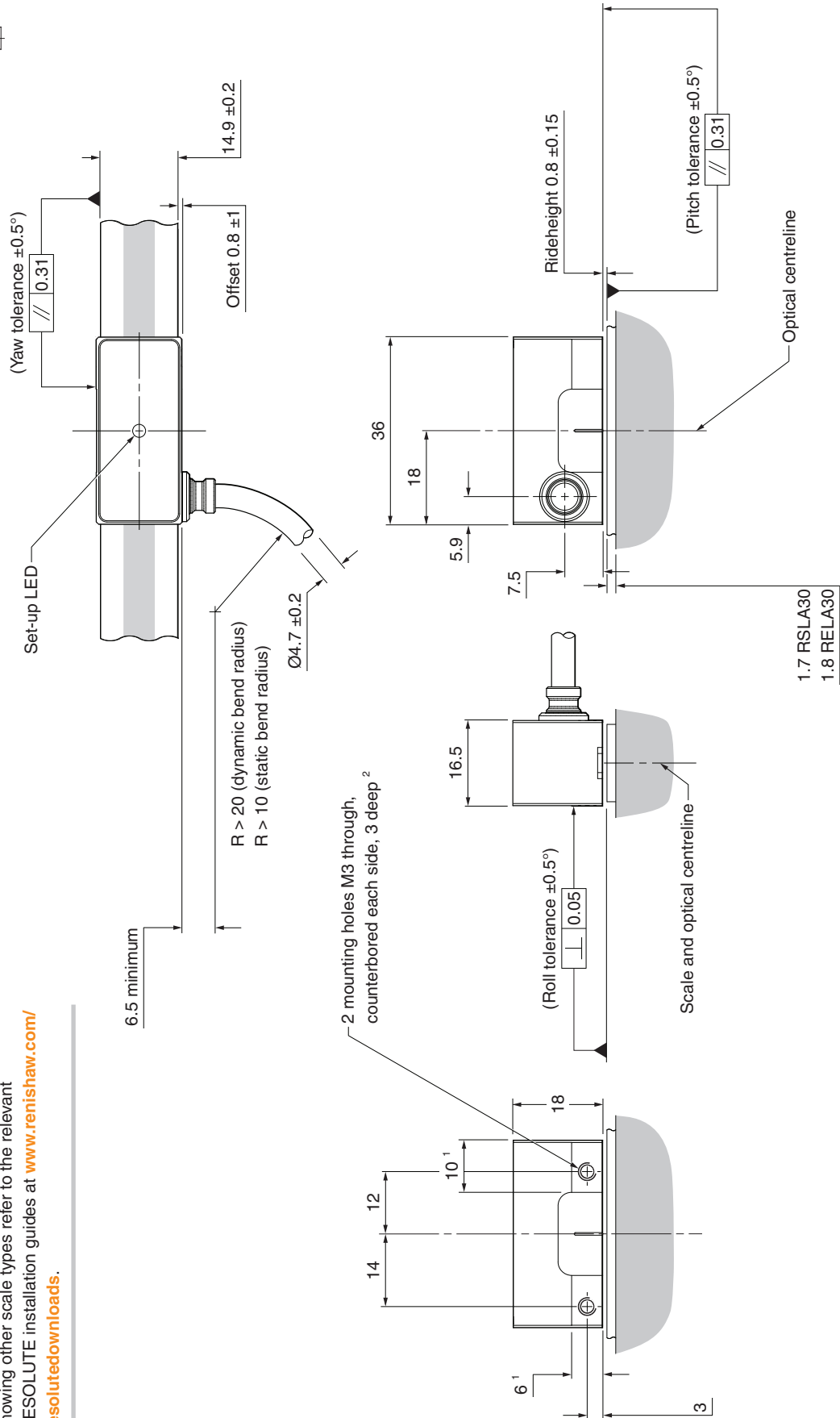

**NOTE:** RESOLUTE readhead shown with RELA30/RSLA30 spar scale. For installation drawings showing other scale types refer to the relevant RESOLUTE installation guides at [www.renishaw.com/resolutedownloads](http://www.renishaw.com/resolutedownloads).

<sup>1</sup> Extent of mounting faces.  
<sup>2</sup> The recommended thread engagement is 6 mm minimum (9 mm including counterbore) and the recommended tightening torque is 0.9 Nm to 1.1 Nm.

# Siemens DRIVE-CLiQ interface drawing

Dimensions and tolerances in mm



## Single readhead input (A-9796-0575)

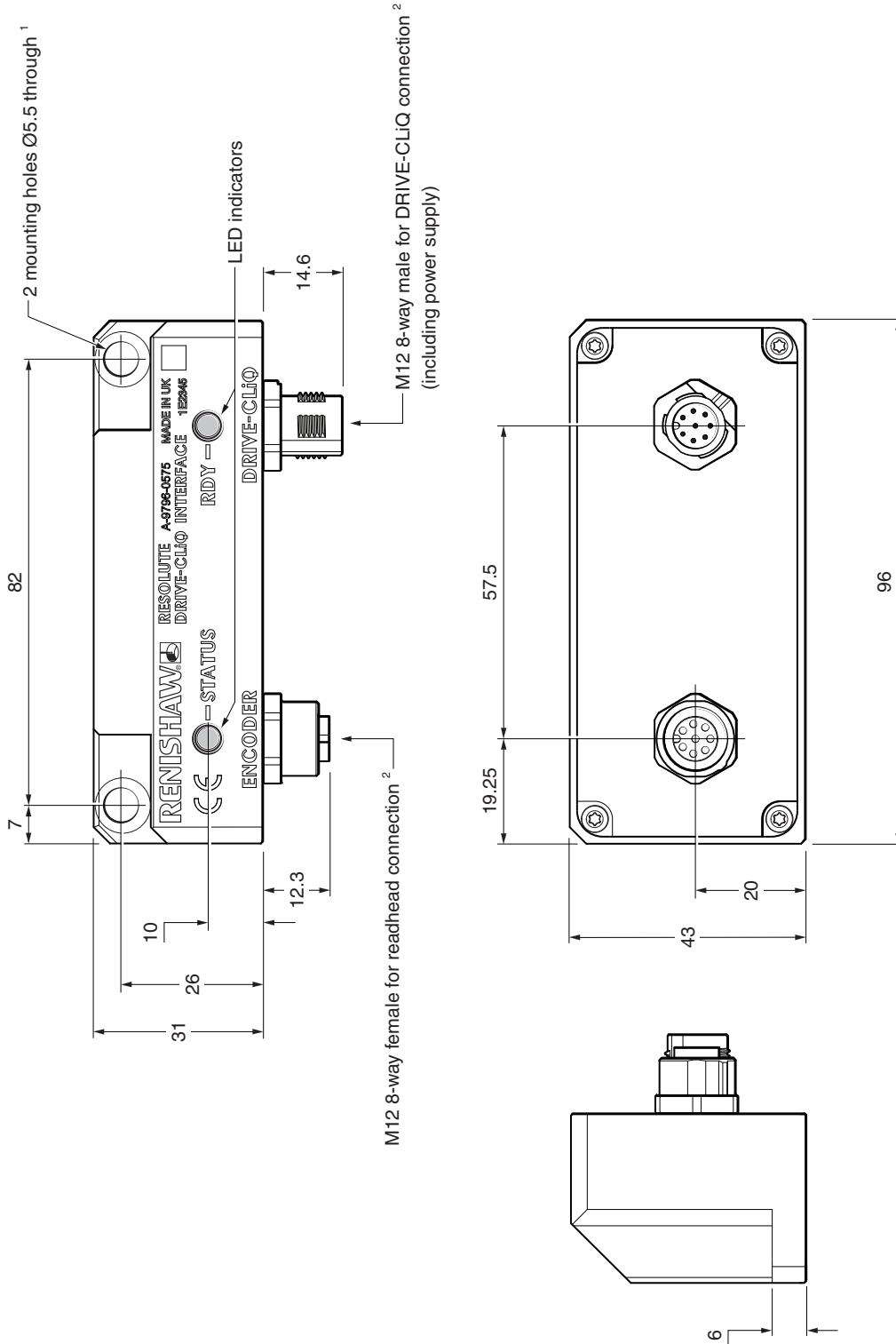

M12 8-way female for readhead connection <sup>2</sup>

M12 8-way male for DRIVE-CLiQ connection <sup>2</sup> (including power supply)

<sup>1</sup> ISO 4762-M5. The recommended thread engagement is  $\geq 5$  mm. The recommended tightening torque is 4 Nm.

<sup>2</sup> Maximum tightening torque 4 Nm.

# Siemens DRIVE-CLiQ interface drawing

Dimensions and tolerances in mm



## Dual readhead input (A-9796-0590)

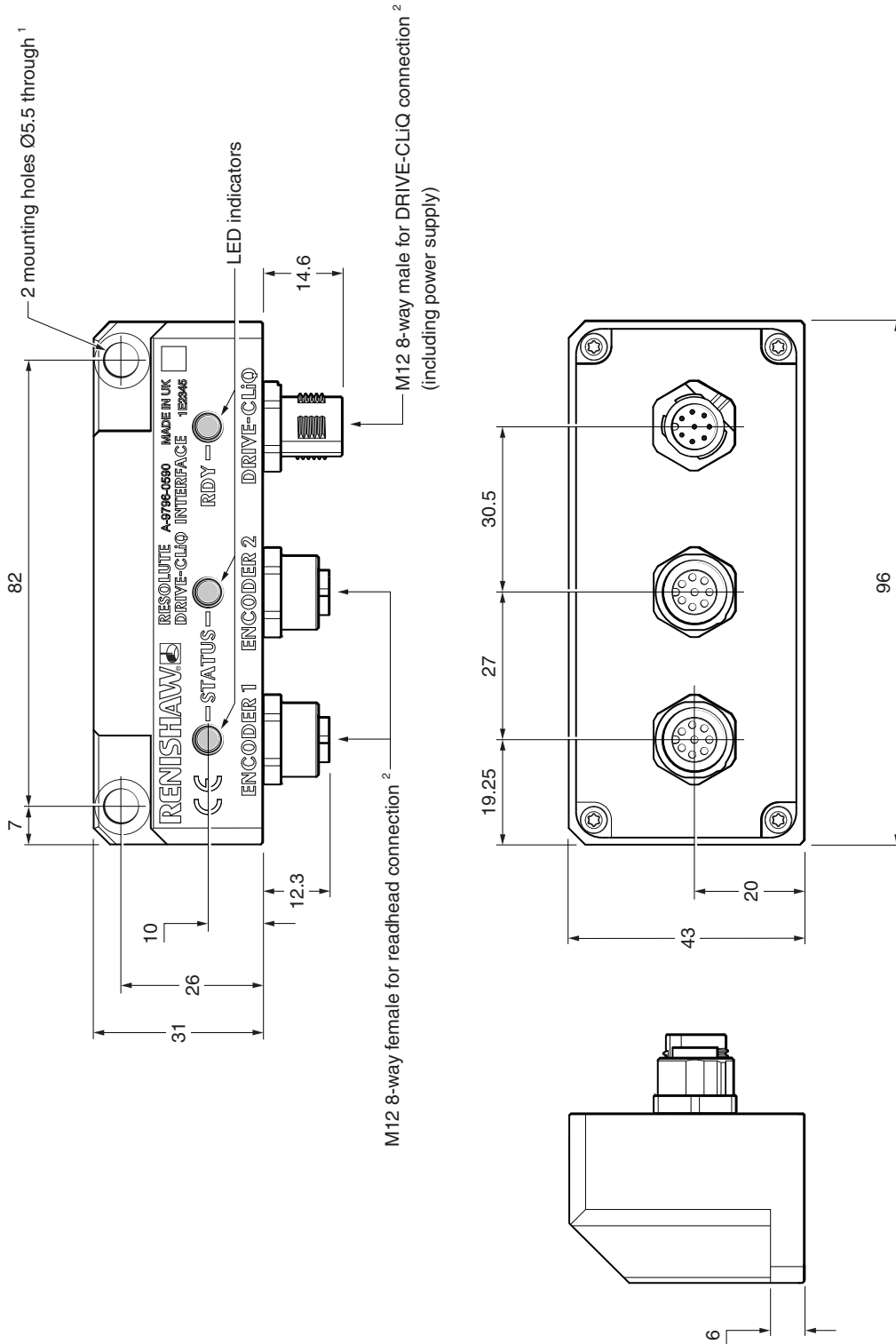

M12 8-way female for readhead connection <sup>2</sup>

M12 8-way male for DRIVE-CLiQ connection <sup>2</sup>  
(including power supply)

<sup>1</sup> ISO 4762-M5. The recommended thread engagement is  $\geq 5$  mm. The recommended tightening torque is 4 Nm.

<sup>2</sup> Maximum tightening torque 4 Nm.

# RESOLUTE BiSS Safety readhead part numbers

## Linear readheads

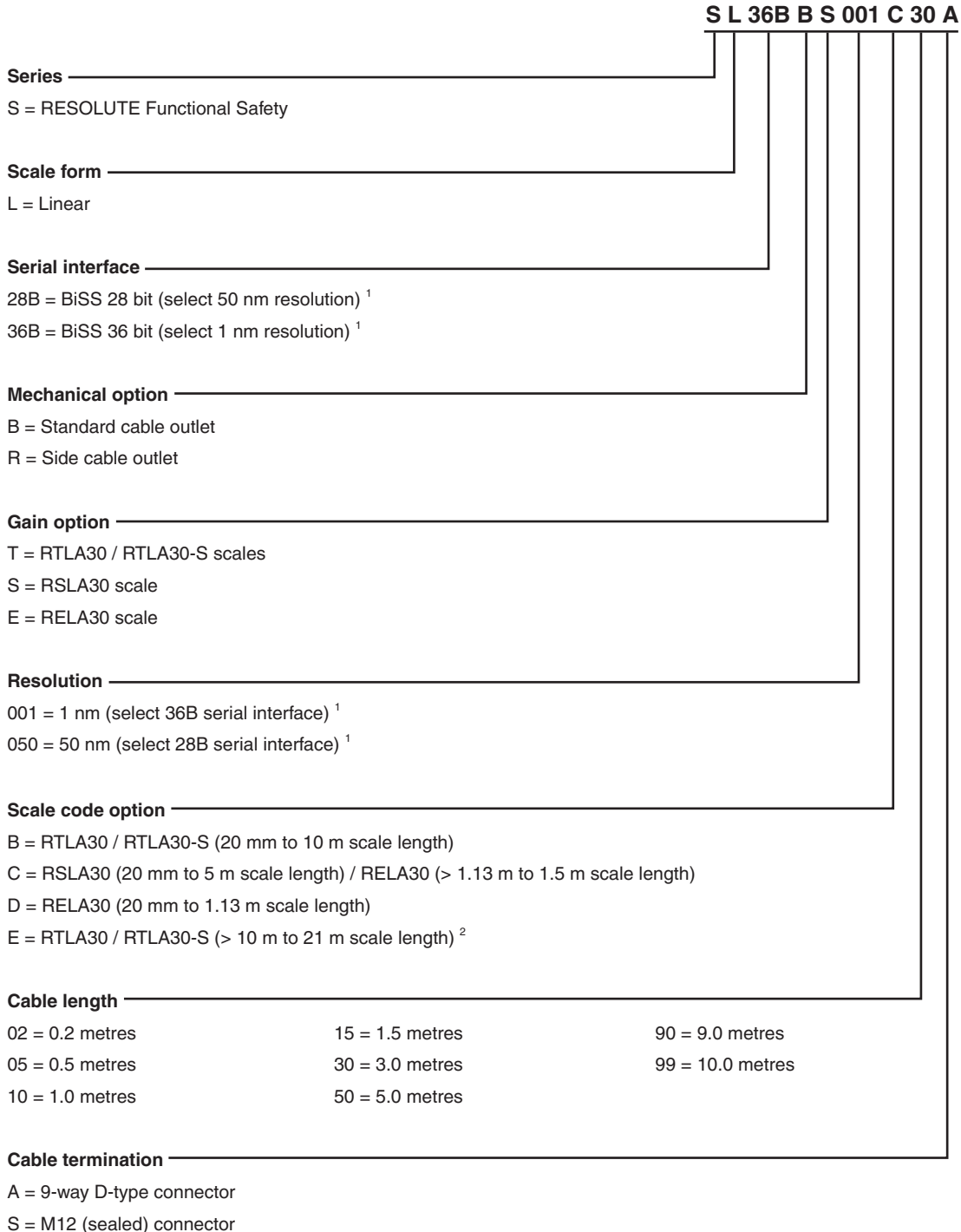

Valid system configurations (readheads and scale) can be checked at [www.renishaw.com/epc](http://www.renishaw.com/epc).

<sup>1</sup> For linear BiSS Safety variants, 'Serial interface' and 'Resolution', must be selected in certain combinations.

- 28B must be selected for 50 nm resolution systems.
- 36B must be selected for 1 nm resolution systems.

Other combinations are not valid.

<sup>2</sup> The maximum scale length may be limited for some serial interfaces and resolutions; refer to 'Linear encoder system' on page 6 for details.

# RESOLUTE BiSS Safety readhead part numbers

## Angular readheads

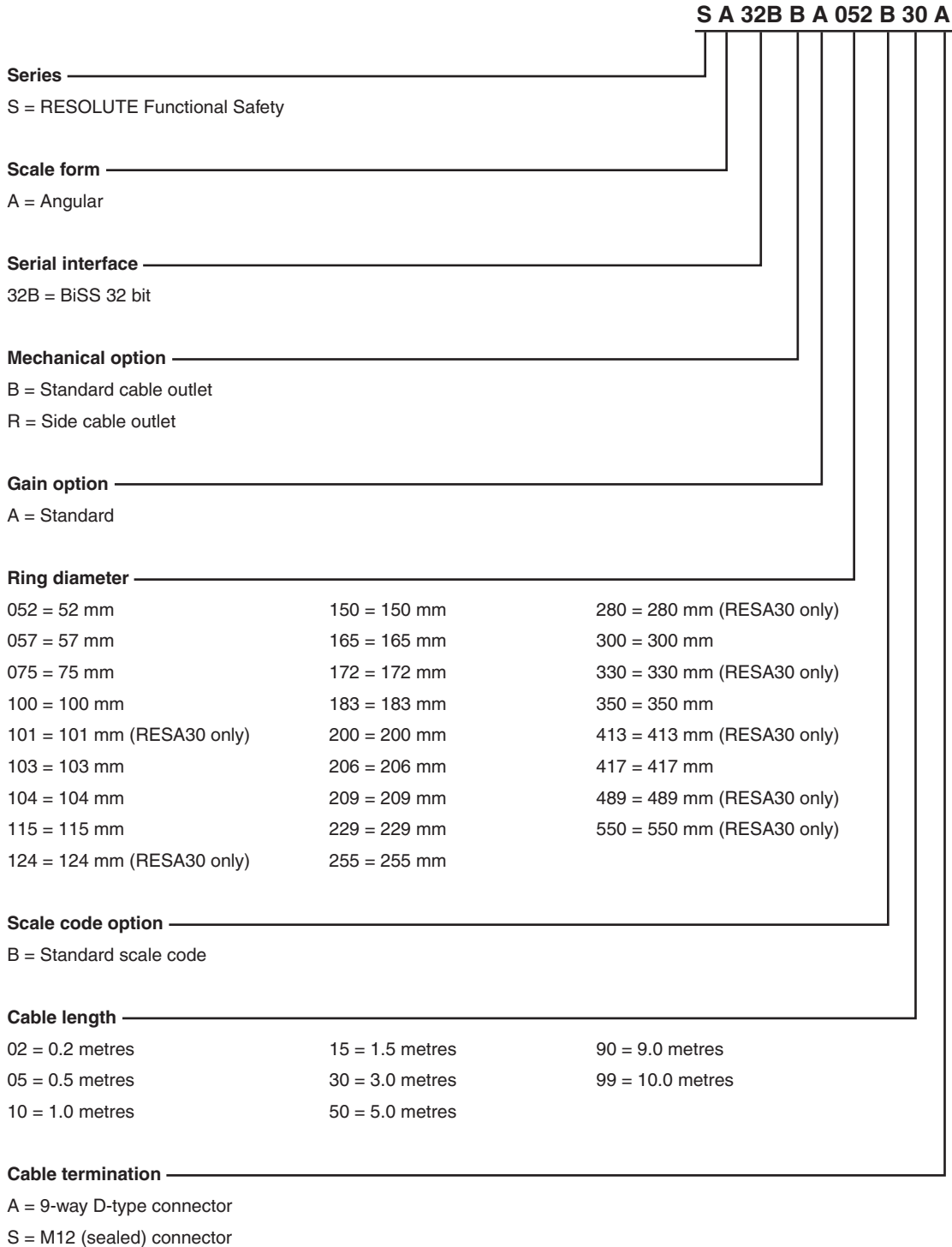

Valid system configurations (readheads and scale) can be checked at [www.renishaw.com/epc](http://www.renishaw.com/epc).



# RESOLUTE FS Siemens DRIVE-CLiQ readhead part numbers

## Linear readheads

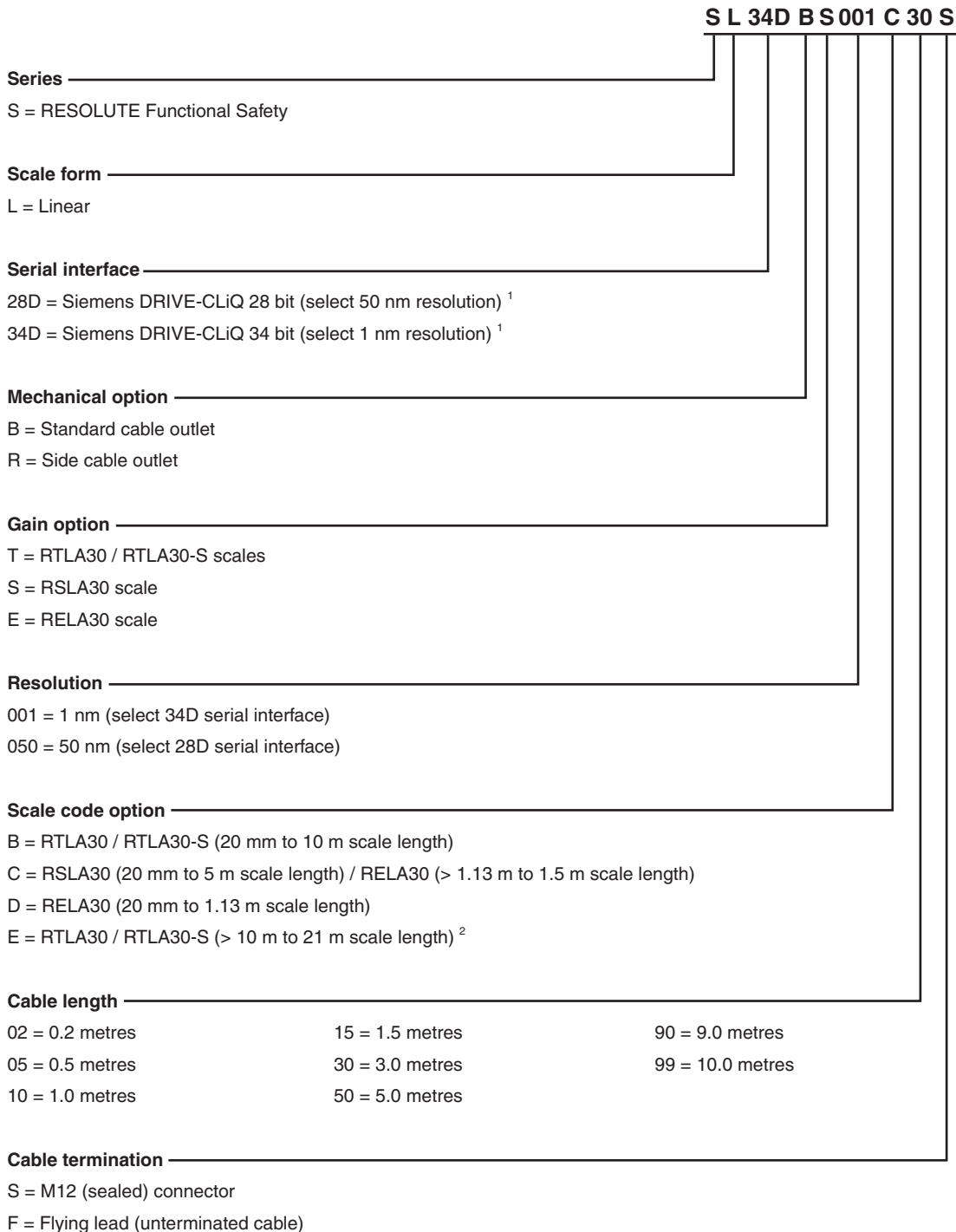

Valid system configurations (readheads and scale) can be checked at [www.renishaw.com/epc](http://www.renishaw.com/epc).

<sup>1</sup> For linear Siemens DRIVE-CLiQ Functional Safety variants, 'Serial interface' and 'Resolution', must be selected in certain combinations.

- 28D must be selected for 50 nm resolution systems.
- 34D must be selected for 1 nm resolution systems.

Other combinations are not valid.

<sup>2</sup> The maximum scale length may be limited for some serial interfaces and resolutions; refer to 'Linear encoder system' on page 6 for details.

# RESOLUTE FS Siemens DRIVE-CLiQ readhead part numbers

## Angular readheads

**S A 29D B A 052 B 30 S**

**Series**

S = RESOLUTE Functional Safety

**Scale form**

A = Angular

**Serial interface**

26D = Siemens DRIVE-CLiQ 26 bit

29D = Siemens DRIVE-CLiQ 29 bit

**Mechanical option**

B = Standard cable outlet

R = Side cable outlet

**Gain option**

A = Standard

**Ring diameter**

052 = 52 mm	150 = 150 mm	280 = 280 mm (RESA30 only)
057 = 57 mm	165 = 165 mm	300 = 300 mm
075 = 75 mm	172 = 172 mm	330 = 330 mm (RESA30 only)
100 = 100 mm	183 = 183 mm	350 = 350 mm
101 = 101 mm (RESA30 only)	200 = 200 mm	413 = 413 mm (RESA30 only)
103 = 103 mm	206 = 206 mm	417 = 417 mm
104 = 104 mm	209 = 209 mm	489 = 489 mm (RESA30 only)
115 = 115 mm	229 = 229 mm	550 = 550 mm (RESA30 only)
124 = 124 mm (RESA30 only)	255 = 255 mm	

**Scale code option**

B = Standard scale code

**Cable length**

02 = 0.2 metres	15 = 1.5 metres	90 = 9.0 metres
05 = 0.5 metres	30 = 3.0 metres	99 = 10.0 metres
10 = 1.0 metres	50 = 5.0 metres	

**Cable termination**

S = M12 (sealed) connector

F = Flying lead (unterminated cable)

Valid system configurations (readheads and scale) can be checked at [www.renishaw.com/epc](http://www.renishaw.com/epc).

## RESOLUTE FS series compatible products

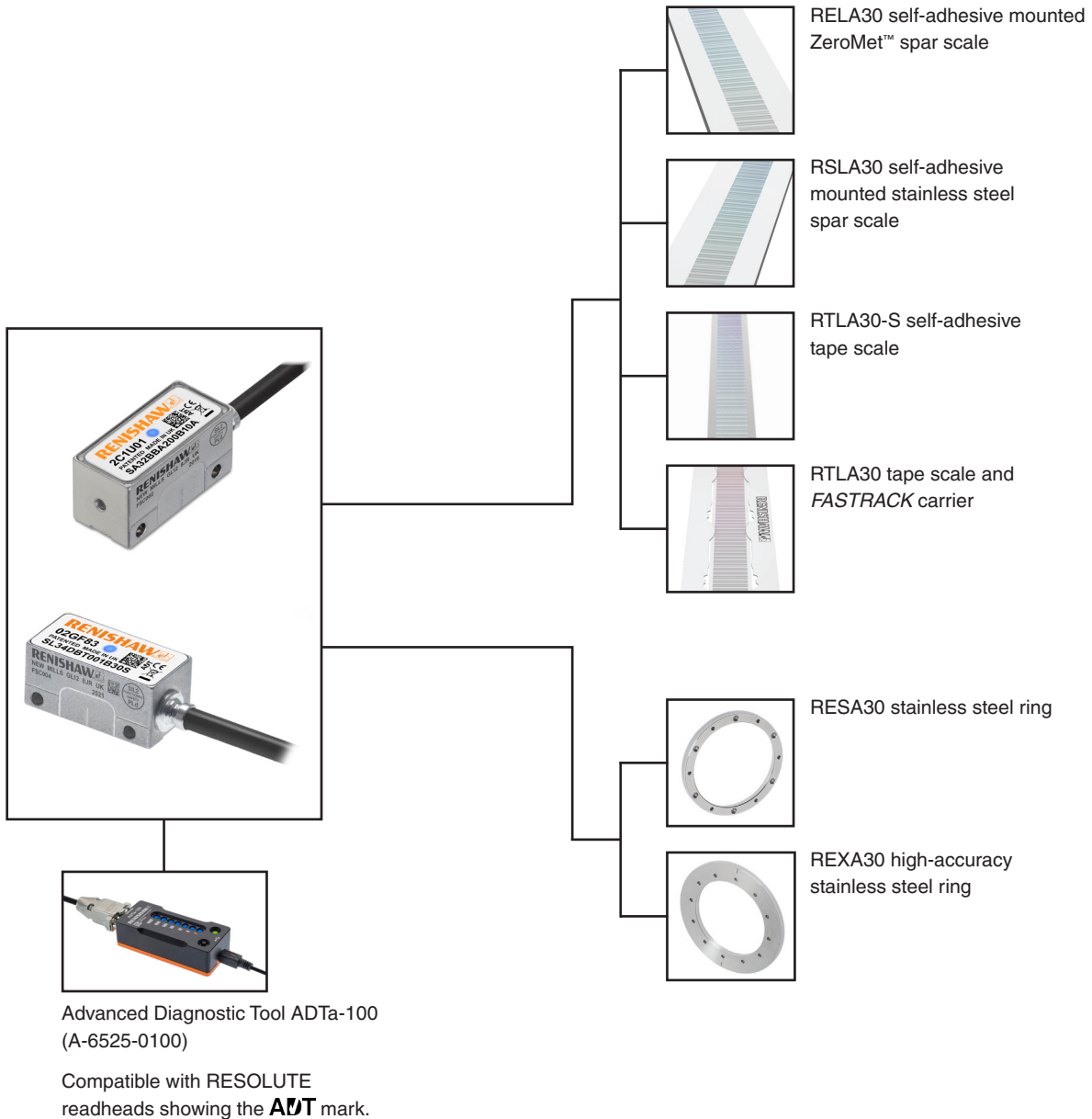

Installation information can be found in the *RESOLUTE™ Functional Safety installation guide and safety manual BiSS Safety encoder system* (Renishaw part no. M-9755-9109) or the *RESOLUTE™ Functional Safety installation guide and safety manual Siemens DRIVE-CLiQ encoder system* (Renishaw part no. L-9796-9134). These documents are available at [www.renishaw.com/fsencoders](http://www.renishaw.com/fsencoders).

For more information about the ADTa-100 and the scale, refer to the relevant data sheets and installation guides which can be downloaded from [www.renishaw.com/resolutedownloads](http://www.renishaw.com/resolutedownloads).

[www.renishaw.com/contact](http://www.renishaw.com/contact)

#renishaw

+44 (0) 1453 524524

uk@renishaw.com

© 2016–2023 Renishaw plc. All rights reserved. This document may not be copied or reproduced in whole or in part, or transferred to any other media or language by any means, without the prior written permission of Renishaw.

RENISHAW® and the probe symbol are registered trade marks of Renishaw plc. Renishaw product names, designations and the mark 'apply innovation' are trade marks of Renishaw plc or its subsidiaries. BiSS® is a registered trademark of iC-Haus GmbH. DRIVE-CLiQ is a registered trademark of Siemens. Other brand, product or company names are trade marks of their respective owners.

WHILE CONSIDERABLE EFFORT WAS MADE TO VERIFY THE ACCURACY OF THIS DOCUMENT AT PUBLICATION, ALL WARRANTIES, CONDITIONS, REPRESENTATIONS AND LIABILITY, HOWSOEVER ARISING, ARE EXCLUDED TO THE EXTENT PERMITTED BY LAW. RENISHAW RESERVES THE RIGHT TO MAKE CHANGES TO THIS DOCUMENT AND TO THE EQUIPMENT, AND/OR SOFTWARE AND THE SPECIFICATION DESCRIBED HEREIN WITHOUT OBLIGATION TO PROVIDE NOTICE OF SUCH CHANGES.

Renishaw plc. Registered in England and Wales. Company no: 1106260. Registered office: New Mills, Wotton-under-Edge, Glos, GL12 8JR, UK.

Part no.: L-9518-0020-01-A

Issued: 07.2023