

2G Motion System

The Power to Be More



KOLLMORGEN

2G Motion System

More Ambitious. Capable. Confident.



The Kollmorgen 2G Motion System harnesses the full performance potential of our next-generation AKM2G servo motors through perfectly matched AKD2G drives that supply unrivaled power density and control. Together, they offer significantly enhanced torque, responsiveness and control in a more compact footprint that provides easy installation and total design flexibility.



Design More Ambitious Machines

Realize your most ambitious designs without compromise. 2G Motion System drives, motors and cables are designed to work together for maximum performance. AKM2G servo motors deliver an average of 30% greater torque with no change in package size or mounting. AKD2G drives include advanced SafeMotion options, expandable I/O, and dual-axis models—all with no increase in drive size.



Depend on More Capable Performance

Our acclaimed WorkBench GUI simplifies motion programming and tuning, while the on-drive graphical display provides the information you need for efficient machine startup, troubleshooting and maintenance. Our co-engineering services give you direct access to motion experts dedicated to helping you achieve the most capable performance through unlimited customization options.



Engage in More Confident Engineering

Count on the highest standards of motion performance perfectly matched to your application, with no risk of under- or over-powered components. Count on dependable supply, application expertise and personalized support that no other motion provider can offer. Count on Kollmorgen to help you bring a reliably superior solution to market, anywhere in the world, with total confidence.

AKD2G Servo Drive

Powerful, Yet Simple, With Integrated SafeMotion to Increase Ease of Use

The new AKD2G servo drive introduces the Kollmorgen Servo on a Chip™ A powerful compute engine that can control two axes simultaneously and up to 28 I/O. While we were at it, we streamlined the design by optimizing the AKD2G for single-cable motors.

Flexible

- » One and two axis variants available
- » Modular design allows the user to specify only the features needed
- » Supports a variety of feedback devices. SFD & HIPERFACE® DSL standard; optional feedbacks include EnDat, BiSS, Analog Sine/Cos encoder, incremental encoder, resolver and more
- » Multiple bus choices for system optimization, including EtherCAT® & FSoE, and CANopen®
- » Over-voltage, current, and temperature detection provided for added dependability
- » Optional SafeMotion Monitor (SMM), SIL3/PLe
- » Dual-channel STO for each axis (up to SIL3/PLe)
- » Industry-leading power density for greater flexibility in mounting
 - Fits into a 10 inch [25.4 cm] deep control panel

Easy to Use

- » Plug-and-play compatibility with Kollmorgen controls and motors
- » WorkBench GUI, acclaimed for customer experience and usability
- » Hybrid motor-power connector is optimized for single-cable motors; No adaptors, no D-sub, no splitters
- » Cage-clamp spring terminal connectors on I/O allow for fast and easy installation
- » Optically isolated I/O reduces noise and eliminates need for additional hardware

Fast

- » Accommodates changing load conditions immediately:
 - Current loop updates in 1.28 μs , nearly 50x the speed of our nearest competitors
 - Velocity and position loops lead the market at 62.5 μs and 125 μs , respectively
- » Servo on a Chip™ includes dual-core ARM™ A9, 800 MHz μP , 1.5 M gates
- » AI-based auto-tuning with a click of a button gets you started quickly
- » Wizard-based tuning uses advanced Bode plot tool to help you efficiently manual-tune when desired
- » Fast data acquisition with TCP/IP Ethernet service channel

*Consult factory on certification status for AKD2G drives.



Dual-Axis AKD2G Servo Drive (shown with optional SMM, feedback and I/O expansion)



Extensive Safety Functions for SafeMotion*

STO (Safe Torque Off)

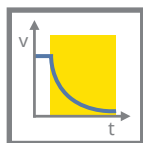

STO safely interrupts the power supply to the motor in the servo drive. The motor becomes torque-free.

SS1 (Safe Stop 1)

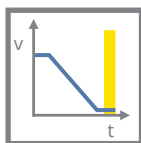

The drive is brought to a standstill by controlled braking. Then the power supply to the motor is safely interrupted and the motor becomes torque-free.

SBC/SBT (Safe Brake Control & Safe Brake Test)

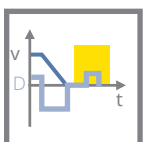

Test function for external brakes and the internal motor holding brake, far simpler than testing brake from PLC/PAC.

SOS² (Safe Operating Stop)

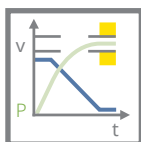

Monitors the stop position reached and triggers SS1 in the event of deviations beyond the specified limits. The control functions of the drive remain active.

SDI¹ (Safe Direction)

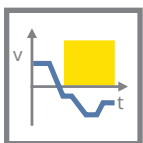

The SDI function ensures that the drive can only move in a defined direction. In the event of an error, SS1 is triggered.

SSR¹ (Safe Speed Range)

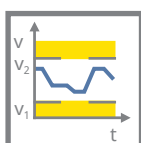

Monitors that the drive observes a defined speed range. In the event of an error, SS1 is triggered.

SLS¹ (Safe Limited Speed)

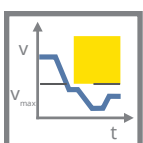

Monitors that the drive observes a defined speed limit. In the event of an error, SS1 is triggered.

SS2¹ (Safe Stop 2)

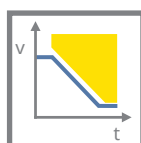

The drive is brought to a standstill by controlled braking and subsequently remains in controlled standstill. The control functions of the drive are maintained.

SLP¹ (Safe Limited Position)

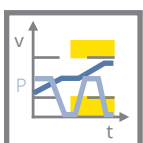

Monitors the absolute position of the drive. If the limit value is reached or the brake torque is too low to keep the drive within the limit value, SS1 is triggered.

SLI¹ (Safe Limited Increments)

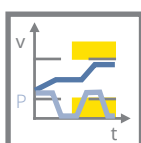

Monitors the relative position of the drive with respect to the current position when activating the SLI function. SS1 is triggered when the prescribed limit value is reached.

* Visit kollmorgen.com or contact your sales representative to confirm availability.

1. Requires "Safe" feedback device.

2. SS1 if faulted is the default setting. Users can easily configure this or other actions in WorkBench.

AKD2G Servo Drive

AKD2G Means Unparalleled Connectivity

Base Model

The base model of Kollmorgen's AKD2G includes all of the performance described previously, and is optimized to interface to a single-connector motor with Kollmorgen's Smart Feedback or HIPERFACE® DSL. It also offers 16 I/O, 160x128-pixel graphical display, removable SD card, and your choice of motionbusses.

Extended I/O Variant

The extended I/O variant offers everything on the base model, plus I/O expansion.

This I/O expansion includes the 15-pin D-sub for legacy feedbacks or dual-loop operation; it also includes an additional 12 I/O for a total of 28 I/O. The options fit in the same package as the base model.

SafeMotion Monitor (SMM)

The Extended I/O model is offered with the optional SMM. The SMM converts some of the I/O into "Safe" I/O, and allows the drive to interface safely to an FSoE master. Again, these options fit in the same package as the base model.



Dual-Axis AKD2G 480 Vac
(shown with optional feedback and I/O expansion)

Dual-Axis AKD2G 240 Vac
(shown with optional SMM, feedback and I/O expansion)



120/240 Vac	Continuous Current	Peak Current	Typical Shaft Power	Internal Regen		Height	Width	Depth	Depth w/ cable bend radius
	(Arms)	(Arms)	(kW)	(W)	(Ω)	mm (in)	mm (in)	mm (in)	mm (in)
AKD2G-SPx-6V03S	3	9	1	100	15	233 (9.15)	75 (2.95)	180 (7.09)	225 (8.86)
AKD2G-SPx-6V06S	6	18	2						
AKD2G-SPx-6V12S	12	30	4						
AKD2G-SPx-6V03D	3 & 3	9 & 9	1 & 1						
AKD2G-SPx-6V06D	6 & 6	18 & 18	2 & 2						

240/480 Vac	Continuous Current	Peak Current	Typical Shaft Power	Internal Regen		Height	Width	Depth	Depth w/ cable bend radius
	(Arms)	(Arms)	(kW)	(W)	(Ω)	mm (in)	mm (in)	mm (in)	mm (in)
AKD2G-SPx-7V03S	3	9	2	100	33	270 (10.6)	75 (2.95)	180 (7.09)	225 (8.86)
AKD2G-SPx-7V06S	6	18	4						
AKD2G-SPx-7V12S	12	30	8						
AKD2G-SPx-7V03D	3 & 3	9 & 9	2 & 2						
AKD2G-SPx-7V06D	6 & 6	18 & 18	4 & 4						

AKD2G Servo Drive

AKD2G Drive Connector Layout

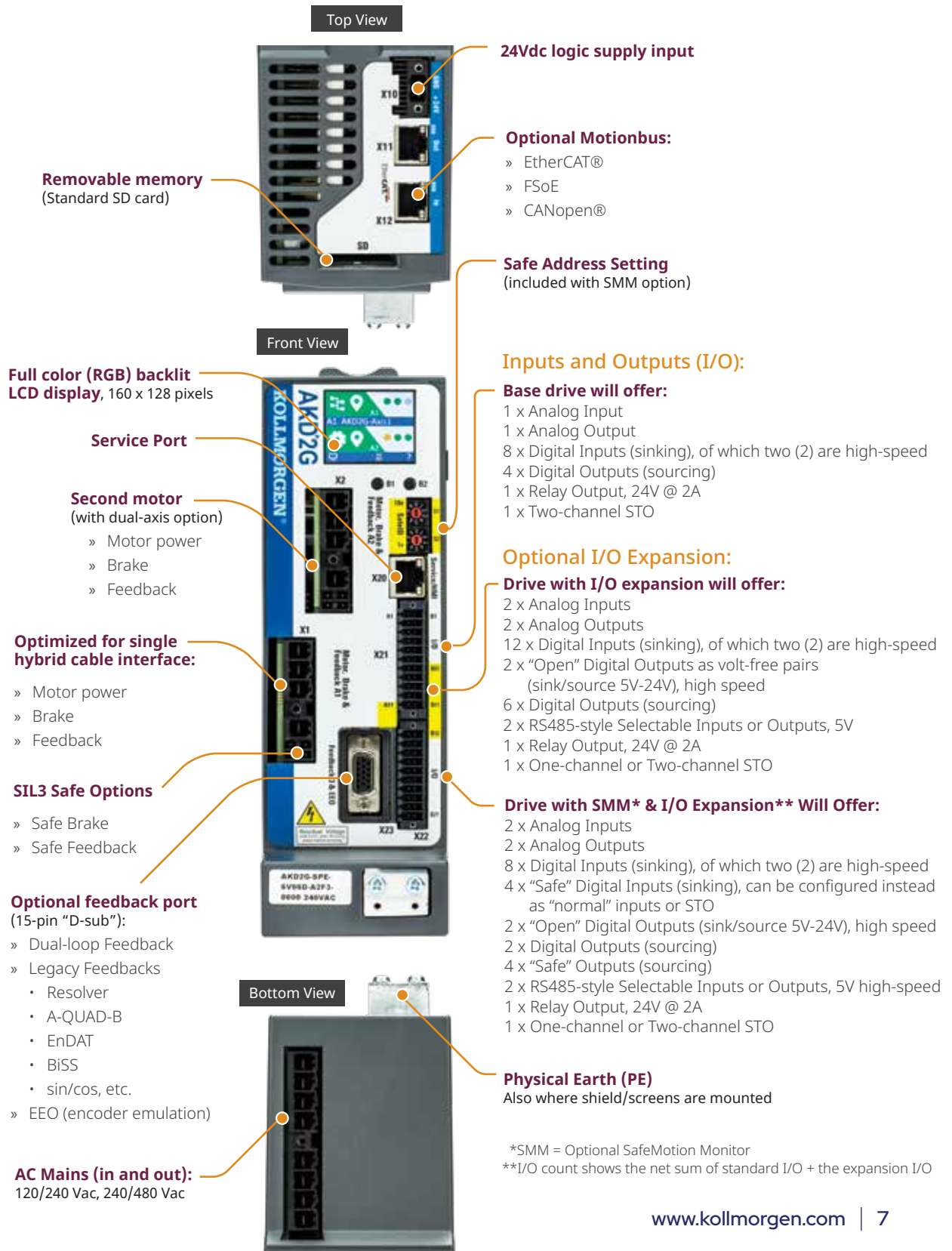

AKM2G Servo Motor

AKM2G represents the latest evolution of the industry-leading AKM motor product family

With significant torque increases in the same motor size, OEMs and users can achieve substantial machine performance increases without increasing the size of the motor.

The improved torque density allows a smaller motor to be used, which reduces the machine footprint without sacrificing performance.

- » Extensive Selection of Feedback options to match application and performance requirements
- » Shaft, mounting and connector options for optimal flexibility
- » Holding brake option

Cable Options:

- » Single Cable SFD3 / HIPERFACE DSL / EnDat 2.2*
- » Dual Cable Resolver
- » Single and Dual Cable Co-Engineered options for additional feedback models

Connector Options:

- » Speedtec
- » ytec

Significant continuous torque increases without increased size

Low Friction Shaft Seal Options

- » For High Protection Class
- » Choice of Viton® or Teflon® seals

Feedback Options:

- » SFD3
- » HIPERFACE DSL**
- » EnDat 2.2**
- » Resolver
- » Co-Engineered options for additional feedback models

Holding Brake Option

Thermal Sensor Options:

- » PT-1000 + Avalanche PTC
- » PT-1000
- » Avalanche PTC
- » KTY84-130

*For high current Size 7 motors using the M40 Power connector ENDAT 2.2 feedback is provided in Dual Cable format.

**HIPERFACE DSL and EnDat 2.2 feedbacks provide support for Functional Safety and required for Advanced SafeMotion functions.

AKM2G Servo Motor

Achieve your desired performance in less space

For new machine designs, the AKM2G allows customers to decrease the size, footprint, and complexity of the machine, while still getting the power and performance they need.

The AKM2G drops right into existing machine designs to increase performance, when compared to competing motors, without increasing the size of the motor.

The AKM2G features six sizes with performance levels between 0.18 and 12 kW. It offers selectable options such as feedbacks, mounting configurations, and performance capabilities. Due to the modular structure of the products, Kollmorgen is better equipped than competitors to adapt motors to the requirements of a specific application in parallel with standard production needs. Machine builders are then able to choose from a wider range of standard models that leverage Kollmorgen's extensive product and application knowledge.

The space required for traditional motors

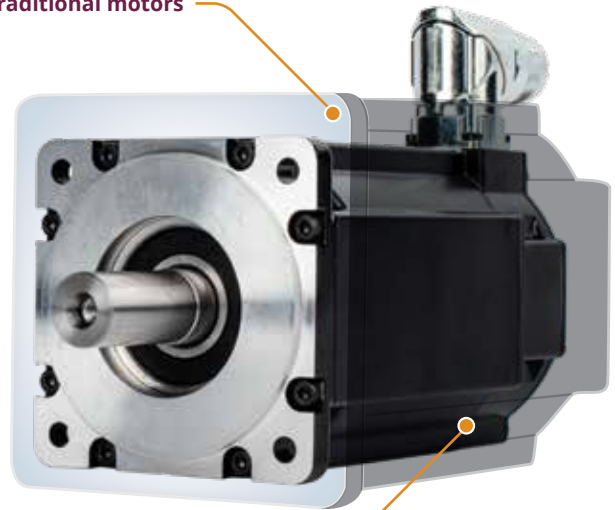

The space required for the AKM2G



AKM2G motors are optimized for use with the AKD2G family of new-generation servo drives. They may also be used with other Kollmorgen family drives or your choice of servo drives. The full capability of the motors are available without the optimized benefits of use with AKD2G drives.

Kollmorgen has been offering single-cable technology since 1995.

AKM2G Series Servo Motor Family



AKM2G Servo Motor

Performance Data*

		Frame															
		AKM2G-2x					AKM2G-3x					AKM2G-4x					
Parameters	Sym	Units	1	2	3	4	5	1	2	3	4	5	1	2	3	4	5
Continuous Torque at Stall	T _c	Nm	0.65	1.12	1.51	1.85	-	1.70	2.90	3.86	-	-	2.87	5.12	6.98	8.51	-
		lb-in	5.76	9.92	13.4	16.3	-	15.1	25.7	34.1	-	-	25.4	45.3	61.8	75.3	-
Rated Speed	N _{rtd}	rpm	8000	8000	8000	8000	-	8000	7600	8000	-	-	6000	6000	6000	5400	-
Rotor Inertia	J _m	kg-cm ²	0.0930	0.1549	0.2169	0.2789	-	0.4264	0.8130	1.200	-	-	0.774	1.36	1.95	2.53	-
		lb-in-s ²	8.23E-05	1.37E-04	1.92E-04	2.47E-04	-	3.77E-04	7.20E-04	1.06E-03	-	-	6.85E-04	1.20E-03	1.72E-03	2.24E-03	-

		AKM2G-5x					AKM2G-6x					AKM2G-7x					
Parameters	Sym	Units	1	2	3	4	5	1	2	3	4	5	1	2	3	4	5
Continuous Torque at Stall	T _c	Nm	6.83	12.0	16.2	20.1	-	-	15.3	21.5	27.0	32.7	23.0	41.1	57.8	72.1	-
		lb-in	60.4	106	144	178	-	-	135	190	239	289	204	364	512	638	-
Rated Speed	N _{rtd}	rpm	6000	5600	5100	4800	-	-	5000	4500	4200	3800	4900	3400	3200	3000	-
Rotor Inertia	J _m	kg-cm ²	4.58	0.1549	6.64	8.70	-	-	9.10	13.0	16.9	20.8	25.9	46.8	67.7	88.6	-
		lb-in-s ²	2.23E-03	2.23E-03	5.88E-03	7.70E-03	-	-	8.05E-03	1.15E-02	1.49E-02	1.84E-02	2.29E-02	4.14E-02	5.99E-02	7.84E-02	-

Kollmorgen continues to offer other AKM® servo motors with performance levels between 0.075 and 19.5 kW, as well as food-grade, wash-down, and the innovative AKMH™ Hygienic Stainless Steel motors for wash-down and food grade applications where machine builders and customers require the highest performance and most durable product in the harshest of environments. AKM motors can also be used on the AKD2G servo drives and benefit from many of its advanced capabilities.



AKM2G Nomenclature

AKM2G - 3 1 A - A N C N CA 0 0

1 2 3 4 5 6 7 8 9 10 11

		Available Motor						Available Options																		
1	Motor Series	AKM2G						Motor Series	AKM2G																	
2	Flange	2	3	4	5	6	7	Flange	2	3	4	5	6	7	9	Feedback Device	Available Options									
	Size in mm	58	72	88	114	142	192									R = Resolver				
3	Rotor Stack Length							6	Shaft								CA = Smart Feedback Device (SFD3)			
	1 = 1 stack		C = Closed Keyway	GU = Multi-turn hipurface DSL				
	2 = 2 stacks		N = Smooth	LD = Multi-turn inductive ENDAT 2.2				
	3 = 3 stacks		7	Connector								10	Thermal Sensor							
	4 = 4 stacks			C = Dual right angle M23	0 = PT-1000 + Avalanche PTC				
	5 = 5 stacks			D = Single right angle M23	1 = PT-1000				
4	Motor Winding										G = Dual straight M23	2 = Avalanche PTC				
	A, B, C...			H = Dual right angle M40	3 = KTY84-130 (or equivalent)				
5	Mount										J = Single right angle M40	11	Shaft Seal/Customization									
	Metric IEC			Y = y-tec® connector	0 = No seal				
											8	Brake								V = Viton spring lip seal (wet enviro.)	
																N = No Brake			
																2 = 24 V dc brake			
																	T = Mineral filled PTFE (dry enviro.)			

*Values shown are representative of each model. Refer to the AKM2G Selection Guide, Motioneering, or the AKM2G Installation Manual for exact information on specific models.

AKM2G Servo Motor

Dimensional Overview

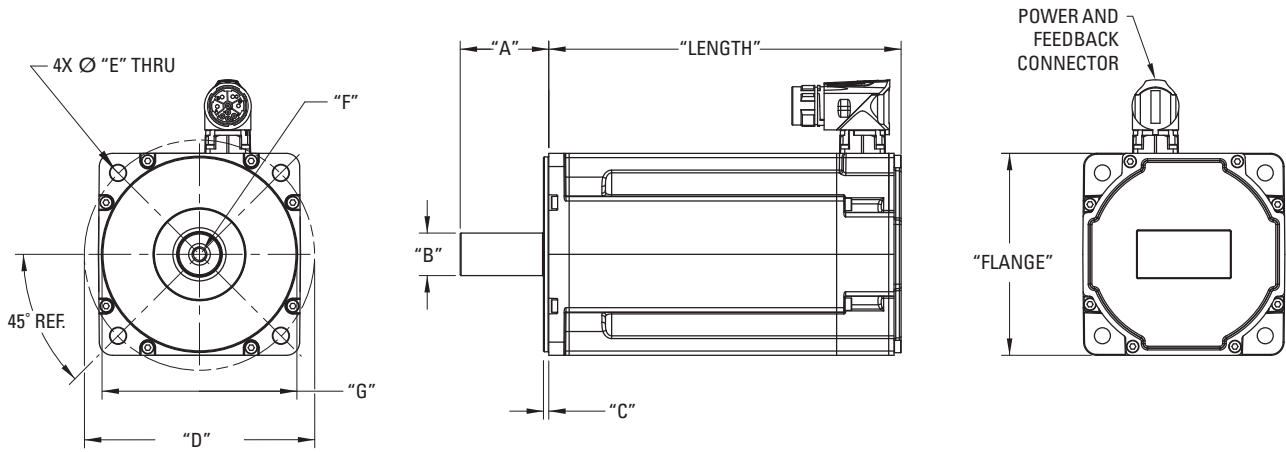

AKM2G Series	Flange IEC	Length Stacks					A	Ø B	C	Ø D	Ø E	F	Ø G
		1	2	3	4	5							
AKM2G2x	58 [2.28]	111 [4.38]	130 [5.13]	149 [5.89]	168 [6.65]	-	23.0 [0.91]	11.0 [0.433]	2.50 [0.98]	63.0 [2.48]	5.5 [0.217]	M4 DIN 332	40.0 [1.57]
		150 [5.91]	169 [6.67]	189 [7.43]	208 [8.19]	-							
AKM2G3x	72 [283]	121 [4.78]	153 [6.01]	184 [7.23]	-	-	30.0 [1.18]	14.0 [0.551]	2.50 [0.98]	75.0 [12.95]	5.5 [0.217]	M5 DIN 332	60.0 [2.36]
		163 [6.40]	194 [7.63]	225 [8.85]	-	-							
AKM2G4x	88 [3.46]	125 [4.91]	151 [5.94]	177 [6.97]	203 [8.01]	-	40.0 [1.57]	19.0 [0.748]	3.00 [0.118]	100.0 [3.94]	6.6 [0.259]	M6 DIN 332	80.0 [3.15]
		172 [6.79]	199 [7.82]	225 [8.85]	251 [9.89]	-							
AKM2G5x	114 [4.49]	143 [5.62]	172 [6.78]	202 [7.94]	231 [9.09]	-	50.0 [1.97]	24.0 [0.945]	3.00 [0.118]	130.0 [5.12]	9.0 [0.354]	M8 DIN 332	110.0 [4.33]
		200 [7.87]	229 [9.02]	259 [10.18]	288 [11.34]	-							
AKM2G6x	142 [5.59]	-	168 [6.62]	190 [7.49]	212 [8.35]	234 [9.22]	58.0 [2.28]	32.0 [1.26]	3.50 [0.138]	165.0 [6.50]	10.19 [0.401]	M12 DIN 332	130.0 [5.12]
		-	234 [9.21]	256 [10.07]	278 [10.94]	300 [11.81]							
AKM2G7x	192 [7.56]	169 [6.66]	203 [7.99]	237 [9.33]	271 [10.67]	-	80.0 [3.15]	38.0 [1.50]	4.00 [0.157]	215.0 [8.47]	13.4 [0.527]	M12 DIN 332	180.0 [7.087]
		247 [9.71]	281 [11.05]	315 [12.38]	349 [13.72]	-							

Dimensions in mm [inches]

Nominal dimensions shown for resolver and Smart Feedback SFD3 motors of less than 20 amps continuous. See individual motor schematics for tolerances and complete dimensions, including other feedbacks and motors rated greater than 20 amps continuous.



More Expertise for a More Successful Machine

Our global engineering, service and support network provides deep knowledge of all the major industries that rely on advanced motion control and automation technology. We offer world-class engineering expertise, self-service design tools, personalized field service, and easy access to our design, application and manufacturing centers in strategic locations across the globe.

About Kollmorgen

Kollmorgen has more than 100 years of motion experience, proven in the industry's highest-performing, most reliable motors, drives, linear actuators, gearheads, AGV control solutions and automation platforms. We deliver breakthrough solutions that are unmatched in performance, reliability and ease of use, giving machine builders an irrefutable marketplace advantage.

Kollmorgen is a brand of Altra Industrial Motion Corp. (NASDAQ: AIMC), a premier global designer and producer of a wide range of motion control and power transmission solutions. With engineered components and systems that provide the essential control of equipment speed, torque, positioning, and other functions, Altra products can be used in nearly any machine, process or application involving motion.

KOLLMORGEN

www.kollmorgen.com

Specifications are subject to change without notice. It is the responsibility of the product user to determine the suitability of this product for a specific application. All trademarks are the property of their respective owners

© 2020 Kollmorgen Corporation. All rights reserved