

aerospace  
climate control  
**electromechanical**  
filtration  
fluid & gas handling  
hydraulics  
pneumatics  
process control  
sealing & shielding



## AC30 Variable Speed Drive

For Open and Closed-Loop Applications  
0.75 - 250 kW Standard Drive



ENGINEERING YOUR SUCCESS.



**WARNING – USER RESPONSIBILITY**

**FAILURE OR IMPROPER SELECTION OR IMPROPER USE OF THE PRODUCTS DESCRIBED HEREIN OR RELATED ITEMS CAN CAUSE DEATH, PERSONAL INJURY AND PROPERTY DAMAGE.**

- This document and other information from Parker-Hannifin Corporation, its subsidiaries and authorized distributors provide product or system options for further investigation by users having technical expertise.
- The user, through its own analysis and testing, is solely responsible for making the final selection of the system and components and assuring that all performance, endurance, maintenance, safety and warning requirements of the application are met. The user must analyze all aspects of the application, follow applicable industry standards, and follow the information concerning the product in the current product catalog and in any other materials provided from Parker or its subsidiaries or authorized distributors.
- To the extent that Parker or its subsidiaries or authorized distributors provide component or system options based upon data or specifications provided by the user, the user is responsible for determining that such data and specifications are suitable and sufficient for all applications and reasonably foreseeable uses of the components or systems.

<b>Overview .....</b>	<b>5</b>
<b>Technical Characteristics.....</b>	<b>12</b>
Electrical Characteristics .....	13
Environmental Characteristics .....	13
Standards and Conformance .....	13
Dimensions .....	14
Connections .....	15
<b>Accessories and Options .....</b>	<b>17</b>
Operator Keypad .....	17
Data Storage and Cables .....	17
Mounting and Filter Kits .....	17
Communication Interfaces .....	18
Input and Output Cards.....	20
Anciliary Parts.....	22
Parker Drive Quicktool (PDQ) Software.....	24
Parker Drive Developer (PDD) Software.....	24
<b>Order Code.....</b>	<b>25</b>
Accessories .....	26

# Parker Hannifin

## The global leader in motion and control technologies

### A world class player on a local stage

#### Global Product Design

Parker Hannifin has more than 40 years experience in the design and manufacturing of drives, controls, motors and mechanical products. With dedicated global product development teams, Parker draws on industry-leading technological leadership and experience from engineering teams in Europe, North America and Asia.

#### Local Application Expertise

Parker has local engineering resources committed to adapting and applying our current products and technologies to best fit our customers' needs.

#### Manufacturing to Meet Our Customers' Needs

Parker is committed to meeting the increasing service demands that our customers require to succeed in the global industrial market. Parker's manufacturing teams seek continuous improvement through the implementation of lean manufacturing methods throughout the process. We measure ourselves on meeting our customers' expectations of quality and delivery, not just our own. In order to meet these expectations, Parker operates and continues to invest in our manufacturing facilities in Europe, North America and Asia.

#### Electromechanical Worldwide Manufacturing Locations

##### Europe

Littlehampton, United Kingdom  
Dijon, France  
Offenburg, Germany  
Filderstadt, Germany  
Milan, Italy

##### Asia

Wuxi, China  
Chennai, India

##### North America

Rohnert Park, California  
Irwin, Pennsylvania  
Charlotte, North Carolina  
New Ulm, Minnesota



Offenburg, Germany

#### Local Manufacturing and Support in Europe

Parker provides sales assistance and local technical support through a network of dedicated sales teams and authorized technical distributors throughout Europe.

For contact information, please refer to the Sales Offices on the back cover of this document or visit [www.parker.com](http://www.parker.com)



Milan, Italy



Littlehampton, UK

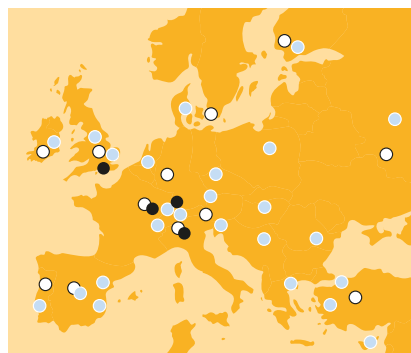

- Electromechanical Manufacturing
- Parker Sales Offices
- Distributors



Dijon, France

# Variable Speed Drive - AC30 Series

## Overview

### Description

AC30 variable speed drive has been designed to provide users with exceptional levels of control, from simple open-loop pumps and fans through to closed-loop process line applications. Its flexible and highly modular construction enables a wide range of communications and I/O modules to be easily added as required.

The AC30 has been designed with simplicity in mind, but this doesn't compromise its functionality. Integrated macros for a range of applications and PLC functionality enable more capable users to create sophisticated control that would previously have required a separate PLC.

Designed for operation in environment class 3C3 and 3C4 for Hydrogen Sulphide (H<sub>2</sub>S) as standard (tested at 25 ppm for 1200 hours), temperatures up to 50 °C with optional integrated EMC filter to C2 1<sup>st</sup> environment and DC link choke to reduce line harmonics. AC30V also complies with RoHS substance restrictions in accordance with EC Directive 2011/65/EU

### Features

#### Flexibility

- Open-loop or optional closed-loop operation with pulse encoder feedback module
- Suitable for operation with AC induction and Permanent Magnet AC (PMAC) servo motors
- Ethernet TCP/IP as standard
- I/O expansion options
- Support for popular industrial fieldbuses
- Chassis or through-panel mount as standard

#### Simplicity

- Advanced control with Parker Drive Developer (PDD) software tool
- Multi-language graphical keypad
- Quick start wizards
- Terminal covers removable with drive in-situ

#### Reliability

- Conformally coated for harsh environment protection as standard
- Spring clamp control terminal connections
- Isolated power stack cooling with removable fan



## Technical Characteristics - Overview

Ratings									
380-480 (±10 %) VAC Supplies Three Phase									
Normal Duty				Heavy Duty					
kW	hp	Output Current [A <sub>rms</sub> ]		kW	hp	Output Current [A <sub>rms</sub> ]		Frame	
		400 V	480 V			400 V	480 V		
1.1	1.5	3.5	3.0	0.75	1	2.5	2.1	D	
1.5	2	4.5	3.4	1.1	1.5	3.5	3.0	D	
2.2	3	5.5	4.8	1.5	2	4.5	3.4	D	
3	4	7.5	5.8	2.2	3	5.5	4.8	D	
4	5	10	7.6	3	4	7.5	5.8	D	
5.5	7.5	12	11	4	5	10	7.6	D	
7.5	10	16	14	5.5	7.5	12	11	E	
11	15	23	21	7.5	10	16	14	E	
15	20	32	27	11	15	23	21	F	
18.5	25	38	36	15	20	32	27	F	
22	30	45	40	18.5	25	38	36	G	
30	40	60	52	22	30	45	40	G	
37	50	73	65	30	40	60	52	G	
45	60	87	77	37	50	73	65	H	
55	75	105	96	45	60	87	77	H	
75	100	145	124	55	75	105	96	H	
90	125	180	156	75	100	145	124	J	
110	150	205	180	90	125	180	156	J	
132	200	260	240	110	150	205	180	J	
160	250	315	302	132	200	260	240	K	
200	300	380	361	160	250	315	302	K	
250	350	440	414	200	300	380	361	K	

**Designed with you in mind**

Throughout every stage of the design process, our engineering teams worked to equip the AC30 with a wealth of features that benefit both OEMs and End-users alike.

Working with the three principles of Flexibility, Simplicity and Reliability, our engineers have created a product that not only delivers class-leading performance but also offers excellent usability in a host of motor control applications.

**Flexibility (F)**

A fully featured list of standard functionality along with the use of common control and option modules allows users to put the drive to work in many different open- or closed-loop applications without having to invest significant time and effort in re-engineering motor control systems.

**Simplicity (S)**

From the clear and concise backlit LCD display to the power terminal covers that can be removed with the drive in the cabinet, AC30 has been engineered to make the process of operating and maintaining the drive as easy as possible.

**Reliability (R)**

Although no one can guarantee problems will never happen, our engineers have taken every possible step to reduce the likelihood of them occurring, as well as including a number of features in the AC30 that will ensure any loss of productivity is minimised and production restarted as safely and as soon as possible.



**Engineered cooling improves reliability**

- Intelligent design minimises force ventilation requirements (R)
- Removable fan improves maintainability (R)
- Isolated power stack cooling path reduces contamination of control electronics (R)



**Compact footprint, chassis or through-panel mounting**

- Multi-position feet with keyhole slots for ease of mounting (F)(S)
- Reduced heat radiation allows side-by-side mounting (F)



**Unobstructed access to power and dynamic brake terminals**

- Terminal covers removable with drive in-situ (S)
- Dynamic brake switch fitted as standard (F)
- Easy access to DC Bus connections (S)



**Suitable for harsh environments**

- AC30 is conformally coated as standard and meets the requirements of environment classes 3C1, 3C2 (all defined substances) plus 3C3 and 3C4 for Hydrogen Sulphide (H<sub>2</sub>S) (F)(R)



**Suited to all environments**

- Internal EMC filter options up to C2 1<sup>st</sup> environment for use in commercial buildings (F)
- CE marked to EN61800-5-1 and NRTL listed to UL508C and C22.2#14 (F)(R)
- DC link chokes above 2.2 kW reduce harmonics to below IEC/EN61000-3-12 limits (F)(R)

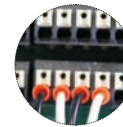

**Expandable I/O capabilities**

- A range of option modules expand AC30 to accommodate application specific I/O (F)
- High-performance, closed-loop control with pulse encoder feedback module (F)
- Spring clamp terminals reduce installation time and risk of loose connections (S)(R)



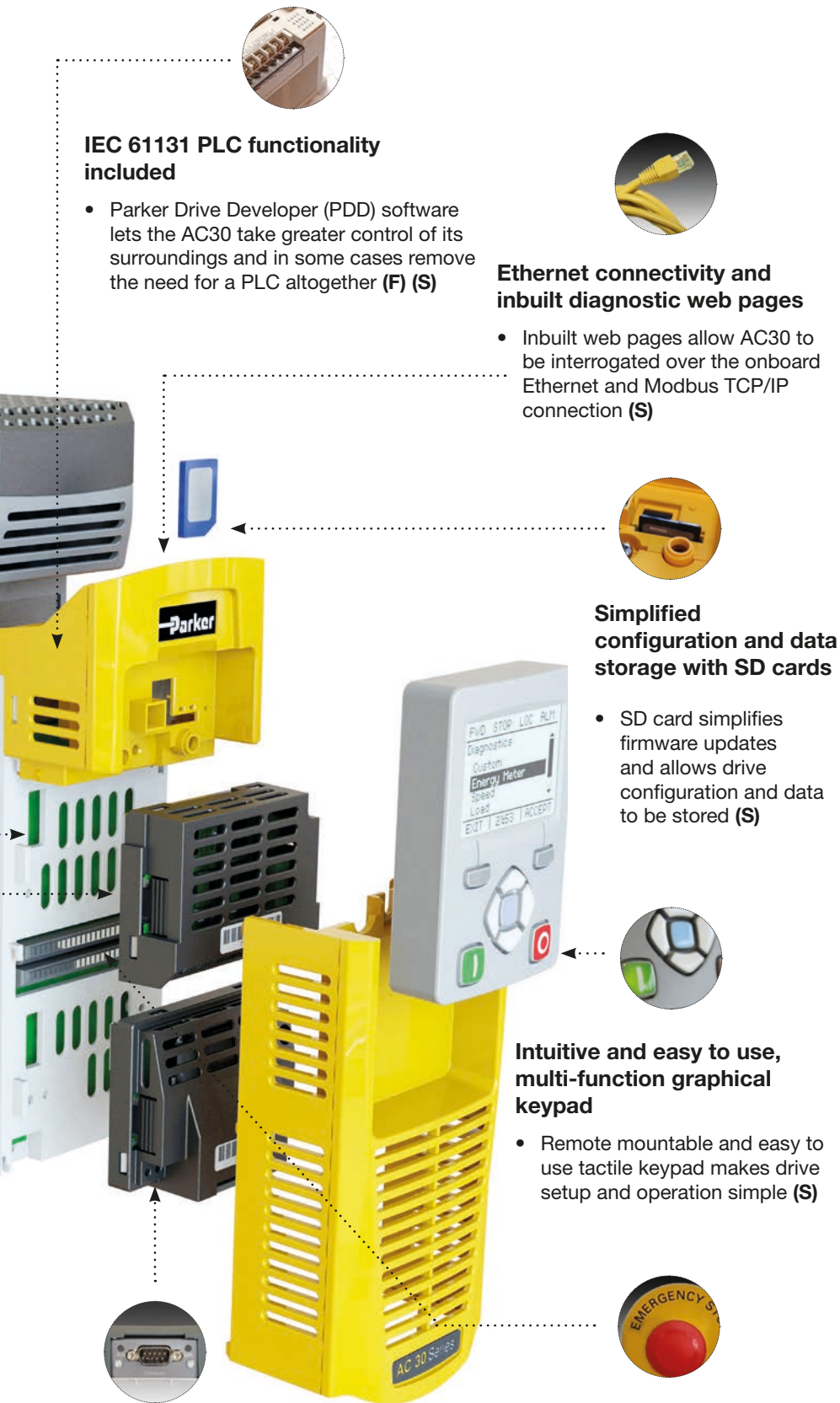

**IEC 61131 PLC functionality included**

- Parker Drive Developer (PDD) software lets the AC30 take greater control of its surroundings and in some cases remove the need for a PLC altogether (F) (S)

**Ethernet connectivity and inbuilt diagnostic web pages**

- Inbuilt web pages allow AC30 to be interrogated over the onboard Ethernet and Modbus TCP/IP connection (S)

**Simplified configuration and data storage with SD cards**

- SD card simplifies firmware updates and allows drive configuration and data to be stored (S)

**Intuitive and easy to use, multi-function graphical keypad**

- Remote mountable and easy to use tactile keypad makes drive setup and operation simple (S)

**Field-fittable communications**

- Seamless integration into automation systems (F)



**Safe-Torque-Off (STO) for safety critical applications**

- Protecting users and machinery against unexpected motor start-up in accordance with EN13849-1 at PLe Cat3 or SIL 3 to EN61800-5-2 (F)(R)

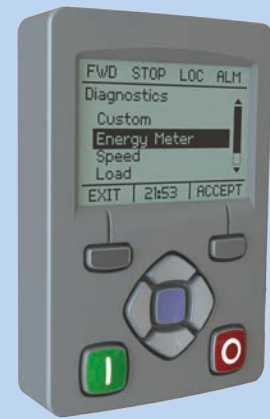

**Graphical keypad**

The tactile IP55 keypad can be mounted either on the drive itself or remotely and provides access to all drive functions.

The backlit LCD display can be configured to present information in any one of a number of different languages, or even in your own custom language with your own user-defined units.

**Simple setup wizard and macros**

- Integrated quick start wizards means you don't have to be an expert to configure the drive within minutes
- Dedicated macros and integrated function blocks simplify the creation of specific motor control applications

**Keypad Remote Mounting**

The graphical keypad can be mounted remotely to the drive with the use of a connecting cable. When remote mounting, a blanking cover can be fitted to the drive in place of the keypad.

## Simple and effective pump and fan control



### Saving energy through speed control

Pumps and fans are widely used throughout industry. Some estimates suggest that a large proportion of these can be as much as 20 % oversized for the application they are used in. When these are operated at a constant speed, a significant amount of the power consumed by the motor is wasted, costing your company considerable amounts of money and creating additional CO<sub>2</sub> emissions.

Matching the speed of pumps and fans to process demands with the AC30V ensures that the motor will always operate at the optimal speed to deliver just the right amount of air or fluid. This can result in significant energy savings. A 20 % reduction in speed will actually reduce energy consumption by almost 50 % and payback can be achieved in **less than 18 months in many cases.**

### Speed control = Savings

- Up to 50 % energy savings
- Improved power factor
- Reduced maintenance
- Quieter operation
- Increased service life
- Reduced carbon footprint

### Improved power factor and service life

Pumps and fans that continuously operate at maximum speed inevitably have shorter life spans and are subject to unnecessary wear and tear. Variable speed drives can help improve service life while also reducing energy consumption and improving the power factor of your installations.

In addition to the cut in energy costs, you'll also see significant savings with maintenance and repair bills and a noticeable reduction in noise pollution as well.

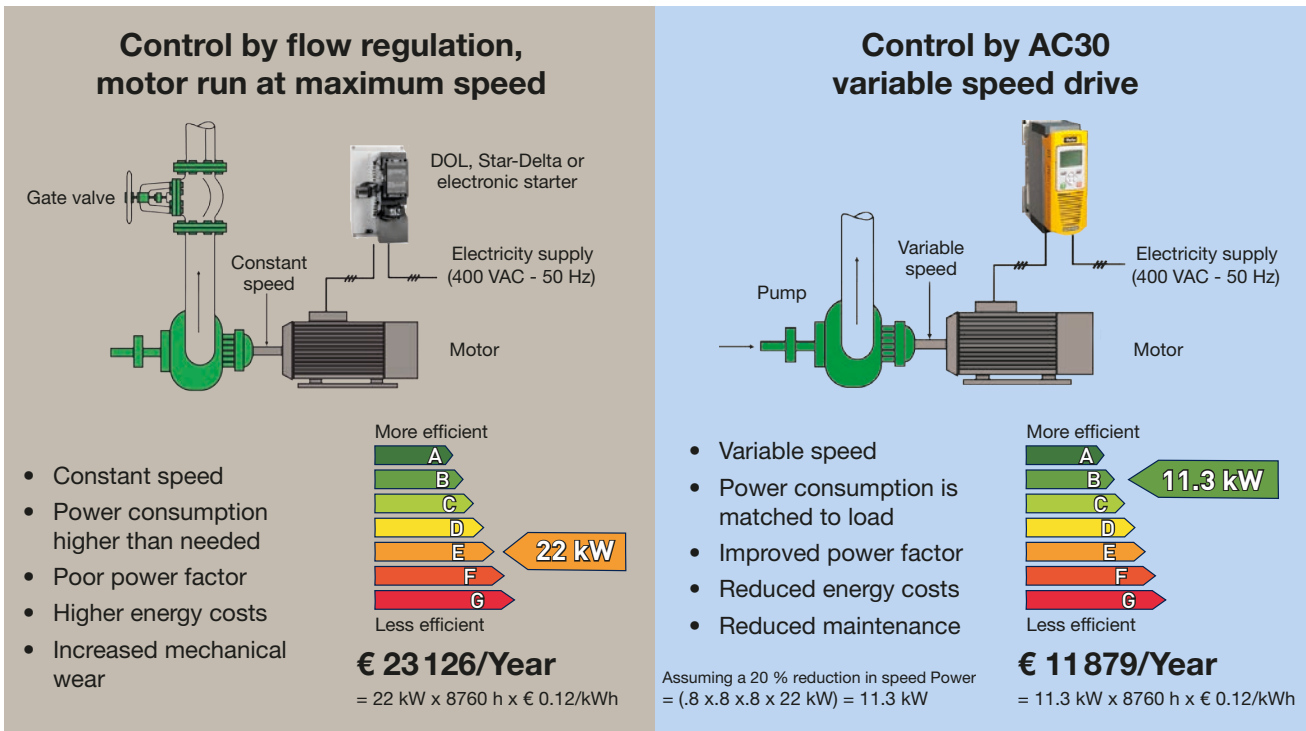

**Total annual energy saving = € 11 247**



## Designed to put you in control of your energy savings

AC30 is supplied complete with a raft of features designed to simplify pump and fan control. In addition to quick setup, dedicated pump and fan macros, there are a number of other features dedicated to energy-saving pump and fan control such as:

### Automatic belt breakage detection

Interactive monitoring of the running conditions of a fan allows AC30 to detect a breakage in the drive belt between the fan and motor, stop the motor and indicate an alarm condition.

### Catching a spinning load - "fly-catching"

The fan control algorithms enable the AC30 to detect when a fan is free-wheeling and to regain control of it before running it at the commanded speed.

### PID Control

Multiple PID control loops can be programmed to monitor process variables and adjust the speed of the motor accordingly to achieve the required variable setpoint.

### Intelligent pump profiles

Our advanced intelligent pump control algorithms monitor motor loads and provides users with a number of features designed specifically for pump control applications, such as:

- Pump dry running protection
- Flow detection (low and no-flow)
- Blocked pump detection

### Essential services (Fire mode)

Selected via digital input, Fire mode will cause the drive to run continuously at the maximum programmed speed ignoring all other control signals and alarm conditions.

### Energy optimisation

Under constant speed conditions, the motor power waveforms from the drive are optimised to reduce motor energy consumption without compromising performance.

### Skip frequencies

Up to 4 speed and frequency bands can be programmed in the AC30, to enable resonant points on the fan to be avoided, reducing vibration, wear and noise.

### Timed run function

10 daily start/stop events can be programmed with different running speeds across a 7 day period. This function requires the optional Real Time Clock (RTC) module and is ideally suited to applications where regular operating patterns or periods of activity need to be accommodated, such as in a production environment.

### Process Timers

Multiple hours-run timers can be programmed to generate text alerts on the drive keypad to coincide with process maintenance intervals.



## Engineered for any motor

In addition to the energy-saving associated with VSD control of pumps and fans. Additional energy saving can be achieved by using permanent magnet (PMAC) servo motors. AC30 offers effective and affordable control of either AC induction motors or PMAC motors.

PMAC motors are up to 10% more efficient and 75% smaller than standard AC induction motors



## Closed-loop operation

An optional pulse encoder feedback module can be added to the AC30 for applications requiring more accurate speed or torque control of AC induction motors

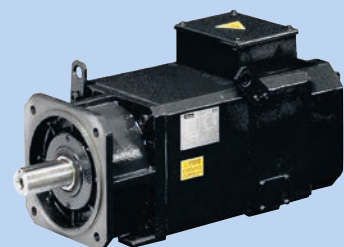

## Application Macros

Making use of pre-defined control logic, application macros enables users to quickly configure the AC30 for control of one of a number of pre-defined functions. Information is presented to the user in a template format which can then be simply and easily populated with the specific details of the application. This removes the complexity of designing the application logic from scratch.

### Basic Speed Control

Set speed and voltage or current with start / stop direction control

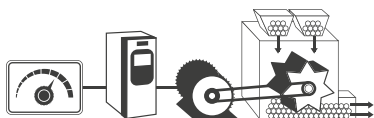

### Automatic/Manual Control

Set to run with local speed setting or external reference

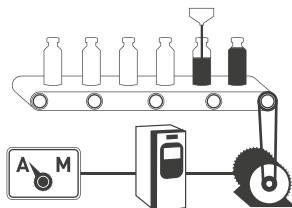

### Preset Speed Control

Select up to 8 pre-programmed speeds using digital inputs

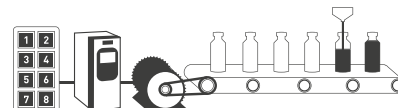

### Raise / Lower

Increase or reduce speed using digital inputs

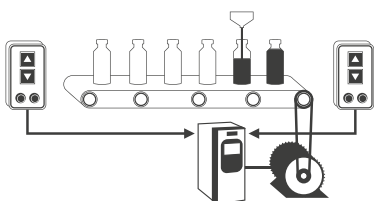

### PID Control

Control the pressure, flow, temperature or any process variable

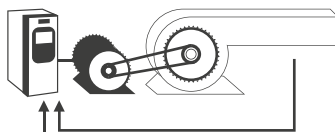

### Torque Control

Control the motor torque limit using an analogue input

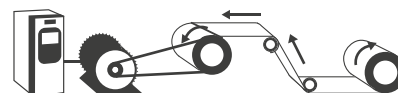

### Fan Control

Dedicated fan control with specific fan functionality



### Pump Control

Dedicated pump control with specific pump functionality

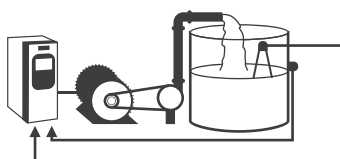

### Hydraulic Pump Applications

Efficient control of hydraulic pump applications, including accumulator charging, pressure control, flow control

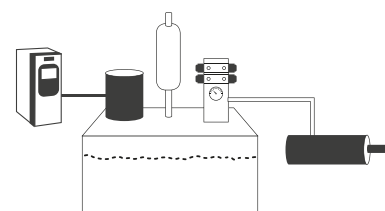

# Applications

With 40 years experience of designing and building AC and DC drives and systems, Parker has a wealth of expertise in a host of different industries. The AC30 has been built on this experience and incorporates many flexible and innovative features, making it ideally suited for use in many industrial and commercial applications. Additional communications, expanded I/O and pulse encoder feedback option modules extend the capabilities of the AC30 still further, making it an extremely flexible and capable solution for all types of open- and closed-loop motor control requirements.

## Typical applications for AC30 include...

- Industrial Pumps
- Industrial Fans
- Conveyor Control
- Air Compressors
- Machine Spindles
- Hydraulic Power Units
- Wire Drawings
- Converting Machines



Industrial Pump Control



Industrial Fan Control



Conveyor Control



Air Compressor Control



Machine Spindle



Hydraulic Pump Control

## Technical Characteristics

### Power Ratings

Order Code	Normal Duty Ratings			Heavy Duty Ratings			Frame
	kW/HP	Output Current $A_{rms}$		kW/HP	Output Current $A_{rms}$		
		400 VAC	480 VAC		400 VAC	480 VAC	
380-480 ( $\pm 10\%$ ) VAC Supplies Three Phase							
31V-4D0004-B...	1.1/1.5	3.5	3.0	0.75/1	2.5	2.1	D
31V-4D0005-B...	1.5/2	4.5	3.4	1.1/1.5	3.5	3.0	D
31V-4D0006-B...	2.2/3	5.5	4.8	1.5/2	4.5	3.4	D
31V-4D0008-B...	3/4	7.5	5.8	2.2/3	5.5	4.8	D
31V-4D0010-B...	4/5	10	7.6	3/4	7.5	5.8	D
31V-4D0012-B...	5.5/7.5	12	11	4/5	10	7.6	D
31V-4E0016-B...	7.5/10	16	14	5.5/7.5	12	11	E
31V-4E0023-B...	11/15	23	21	7.5/10	16	14	E
31V-4F0032-B...	15/20	32	27	11/15	23	21	F
31V-4F0038-B...	18/25	38	36	15/20	32	27	F
31V-4G0045-B...	22/30	45	40	18/25	38	36	G
31V-4G0060-B...	30/40	60	52	22/30	45	40	G
31V-4G0073-B...	37/50	73	65	30/40	60	52	G
31V-4H0087-B...	45/60	87	77	37/50	73	65	H
31V-4H0105-B...	55/75	105	96	45/60	87	77	H
31V-4H0145-B...	75/100	145	124	55/75	105	96	H
31V-4J0180-B...	90/125	180	156	75/100	145	124	J
31V-4J0205-B...	110/150	205	180	90/125	180	156	J
31V-4J0260-B...	132/200	260	240	110/150	205	180	J
31V-4K0300-B...	160/250	300	302	132/200	260	240	K
31V-4K0380-B...	200/300	380	361	160/250	315	302	K
31V-4K0440-B...	250/350	440	414	200/300	380	361	K

See Ordering Information for full order codes and description.

## Electrical Characteristics

<b>Power Supply</b>	<b>400 V Nominal</b>	
<b>Rated Input Voltage</b>	3 x 380...480 VAC ±10 %	
<b>Input Frequency</b>	45...65 Hz	
<b>Maximum Switching Frequency</b>	4 kHz up to maximum of 12 kHz - de-rating may apply	
<b>Overload: Heavy Duty</b>	150 % for 60 s - 180 % for 3 s	
<b>Overload: Normal Duty</b>	110 % for 60 s - 180 % of HD FLC. for 3 s	
<b>Output Frequencies</b>	0...590Hz	0...500 Hz at 4 kHz switching frequency* 0...1000 Hz at 8 kHz switching frequency* 0...1500 Hz at 12 kHz switching frequency*
<b>Earth Leakage Current</b>	>10 mA (all models)	

\*Subject to export license agreement

## Environmental Characteristics

<b>Operating Temperature</b>	0...+40 °C Normal Duty, 0...+45 °C Heavy Duty. Derate up to a maximum of +50 °C
<b>Storage Temperature</b>	-25...+55 °C
<b>Shipping Temperature</b>	-25...+70 °C
<b>Product Enclosure Rating</b>	IP20 - remainder of surfaces (Europe) UL (c-UL) Open Type (North America/Canada)
<b>(Cubicle mounted)</b>	IP20 UL (c-UL) Open Type (North America/Canada)
<b>(Through-panel mounted)</b>	IP20 UL (c-UL) Open Type (North America/Canada)
<b>Altitude</b>	1000 m ASL. Derate output by 1 % per 100 m to a maximum of 2000 m
<b>Operating Humidity</b>	Maximum 85 % relative humidity at 40 °C non-condensing
<b>Atmosphere</b>	Non-flammable, non-corrosive and dust free
<b>Climatic Conditions</b>	Class 3k3, as defined by EN60721-3-3
<b>Chemically Active Substances</b>	For the standard product, compliance with EN60271-3-3 is: <ul style="list-style-type: none"> <li>• Both classes 3C3 and 3C4 for Hydrogen Sulphide gas (H<sub>2</sub>S) at a concentration of 25 ppm for 1200 hours</li> <li>• Both classes 3C1 (rural) and 3C2 (urban) for all 9 defined substances as defined in table 4</li> </ul>
<b>Operating Vibration</b>	Test Fc of EN60068-2-6 10 Hz<=f<=57 Hz sinusoidal 0.075 mm amplitude 57 Hz<=f<=150 Hz sinusoidal 1 g 10 sweep cycles per axis on each of three mutually perpendicular axis
<b>Overvoltage Category</b>	Overvoltage category III (numeral defining an impulse withstand level)
<b>Pollution Degree</b>	Pollution degree II (non-conductive pollution, except for temporary condensation) for control electronics Pollution Degree III (dirty air rating) for through-panel mounted parts

## Standards and Conformance

<b>North America/Canada</b>	Complies with the requirements of UL508C and CSA22.2 #14 as an open-type drive
<b>European LV Directive</b>	This product conforms with the Low Voltage Directive 2006/95/EC
<b>European EMC Directive</b>	CE Marked in accordance with 2004/108/EC
<b>RoHS Compliance</b>	This product complies with RoHS substance restrictions in accordance with EC Directive 2011/65/EU
<b>Reach</b>	This product complies with the REACH regulations EC1907/2006
<b>European Machinery Directive</b>	Safe-Torque-Off (STO) complies with the requirements of ISO13849-1 (Safety-related parts of control systems) at PLe Cat3 or SIL 3 to EN61800-5-2
<b>DNV Marine Certification (Det Norske Veritas)</b>	Complies with the 'Classification of Ships, High Speed & Light Craft and Det Norske Veritas Offshore Standards'. This applies to all AC30 Frequency converters with powers up to 75kW for use in marine and offshore applications

## Dimensions

### Panel Mounting

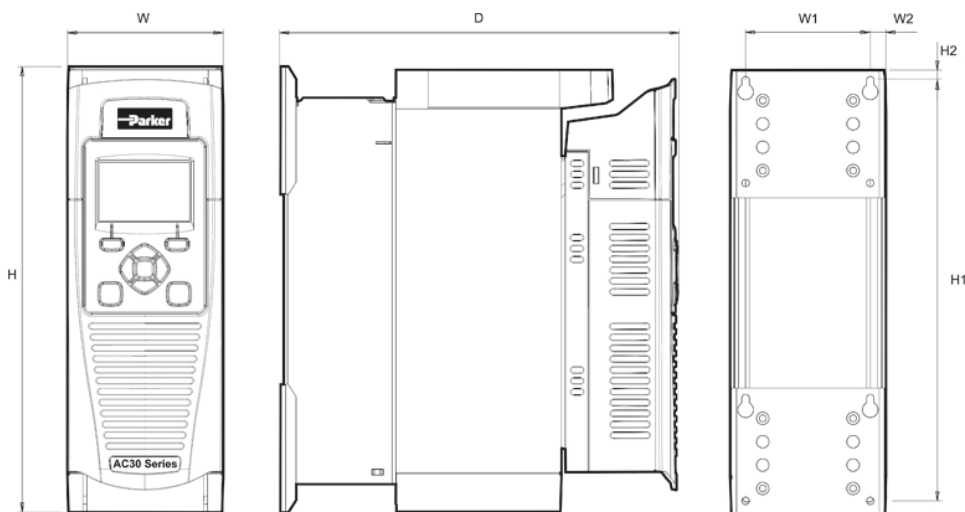

Dimensions [mm]

Model	Max. Weight [kg]	H	H1	H2	W	W1	W2	D	Fixings
Frame D	4.5	286	270	6.5	100	80	10.0	255	Slot 4.5 mm wide. Use M4 fixings
Frame E	6.8	333	320	6.5	125	100	12.5	255	
Frame F	10	383	370	6.5	150	125	12.5	255	
Frame G	22.3	480	465	7.25	220	190	15	287	Slot 5.0 mm wide. Use M5 fixings
Frame H	TBA	670	650	10	260	220	20	331	
Frame J	TBA	800	780	10	330	285	22.5	374	Use M8 fixings
Frame K	TBA	1300	1272	14	400	280	60	385	Use M10 fixings

### Through Panel Mounting

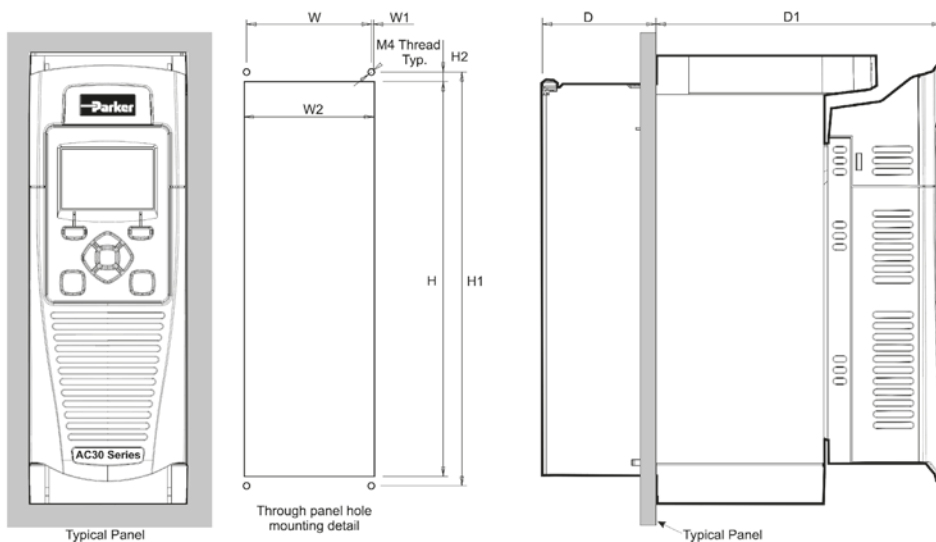

Dimensions [mm]

Model	H	H1	H2	W	W1	W2	D	D1	Fixings
Frame D	250	262	6	79	1.5	82	72	181	Use M4 fixings
Frame E	297	309	6	102	1	104	72	181	
Frame F	347	359	6	127	1	129	72	181	
Frame G	440	455.8	7.9	195	0.4	195.8	95	190	Use M5 fixings
Frame H	617	641	12	218	4.5	227	99	211	Use M6 Fixings
Frame J	745	765	10	275	12.5	300	128	242.6	Use M6 Fixings

Through panel mounting is not possible for frame K.

## Connections

### Power connections

Term.	Description
DB+	Dynamic Brake Resistor
DB-	Dynamic Brake Resistor
DC+	DC Link Bus +Ve
DC-	DC Link Bus -Ve
L1	L1 AC Input Supply
L2	L2 AC Input Supply
L3	L3 AC input Supply
M1	Motor Output 1/U
M2	Motor Output 2/V
M3	Motor Output 3/W

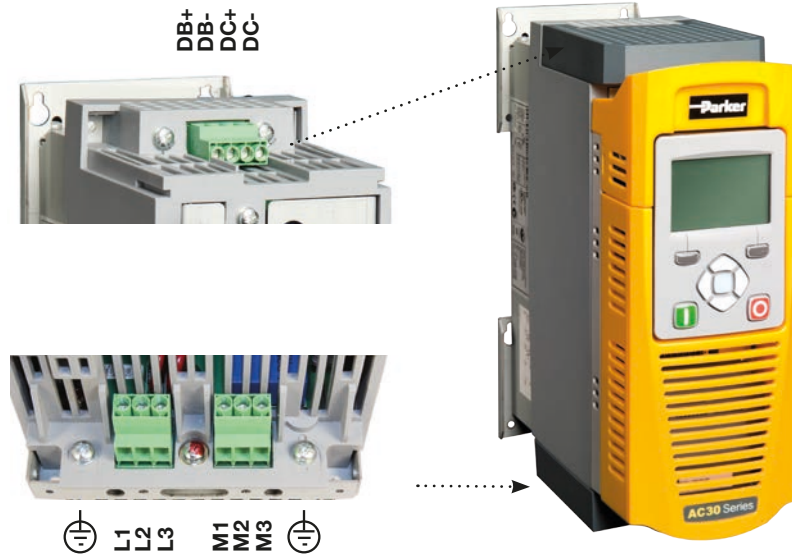

### Safe Torque Off (STO)

The AC30 series features Safe Torque Off functionality as standard, offering users protection against unexpected motor start-up in accordance with EN13849-1 at PLe Cat 3 or SIL 3 to EN61800-5-2.

The STO functionality helps protect personnel and machinery by preventing the drive from restarting automatically. It disables the drive pulses and inhibits the power supply to the motor, so that the drive cannot generate any potentially hazardous movement. The state is monitored internally within the drive.

Term.	Label	Description
X10/01	STO A Input	STO Channel A input signal
X10/02	STO Common	Return signals for STO A and STO B
X10/03	STO B Input	STO Channel B input signal
X10/04	STO Common	Return signals for STO A and STO B
X10/05	STATUS A	STO Status Indication
X10/06	STATUS B	STO Status Indication

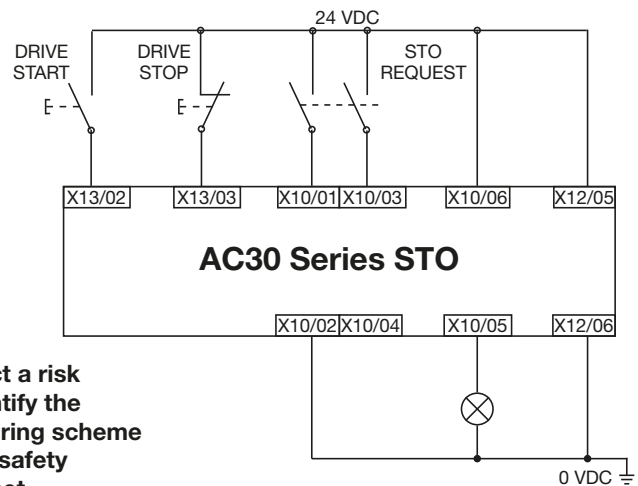

The example wiring diagram shows the minimum connections required to implement STO with the AC30 series AC drives.

**Users must conduct a risk assessment to identify the appropriate STO wiring scheme and ensure that all safety requirements are met.**



**It is the user's responsibility to ensure the safe and correct use of the STO function of the AC30 Series. User's should read and fully understand chapter 6 (Safe Torque Off) of the product user manual. Manual No. HA501718U001**

**Control wiring connections**

Term.	Label
X10/01	STO A Input
X10/02	STO Common Return
X10/03	STO B Input
X10/04	STO Common Return
X10/05	STO Status A
X10/06	STO Status B
X11/01	ANIN 01 Analogue Input ( $\pm 10$ V, 0-10 V, 0-20 mA, 4-20 mA)
X11/02	ANIN 02 Analogue Input ( $\pm 10$ V, 0-10 V)
X11/03	ANOUT 01 Analogue Output ( $\pm 10$ V, 0-10 V)
X11/04	ANOUT 02 Analogue Output (0-10 V, 0-20 mA, 4-20 mA)
X11/05	+10 V Reference
X11/06	-10 V Reference
X12/01	DIGIN04 / DIGOUT 01 Digital In/Out
X12/02	DIGIN05 / DIGOUT 02 Digital In/Out
X12/03	DIGIN06 / DIGOUT 03 Digital In/Out
X12/04	DIGIN07 / DIGOUT 04 Digital In/Out
X12/05	User +24 V Output
X12/06	0 V Common

Term.	Label
X13/01	0V Common
X13/02	DIGIN 1 Digital Input
X13/03	DIGIN 2 Digital Input
X13/04	DIGIN 3 Digital Input
X13/05	+24 V Auxiliary Input
X13/06	0 V Auxiliary Input
X14/01	Relay Output 01 (Contact A)
X14/02	Relay Output 01 (Contact B)
X14/03	Relay Output 02 (Contact A)
X14/04	Relay Output 02 (Contact B)

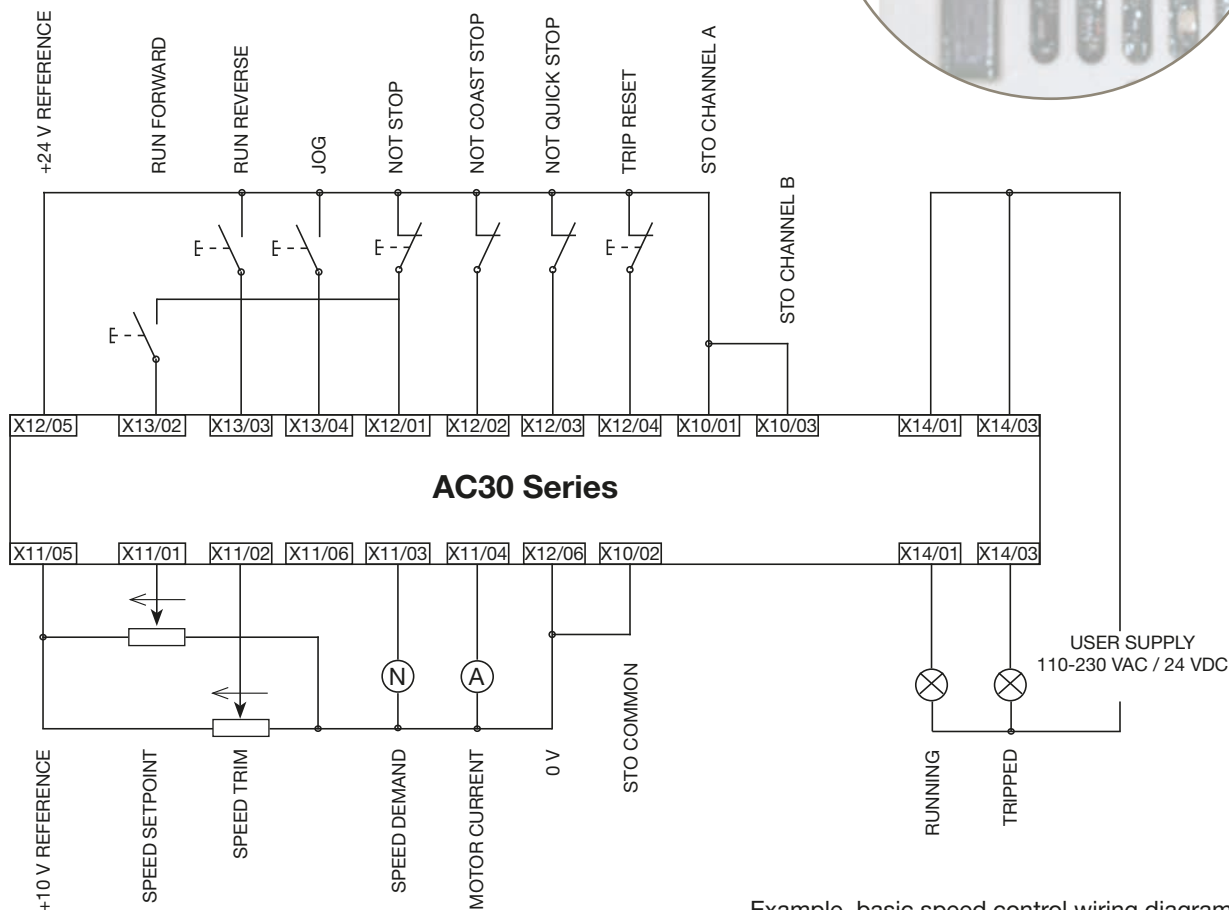
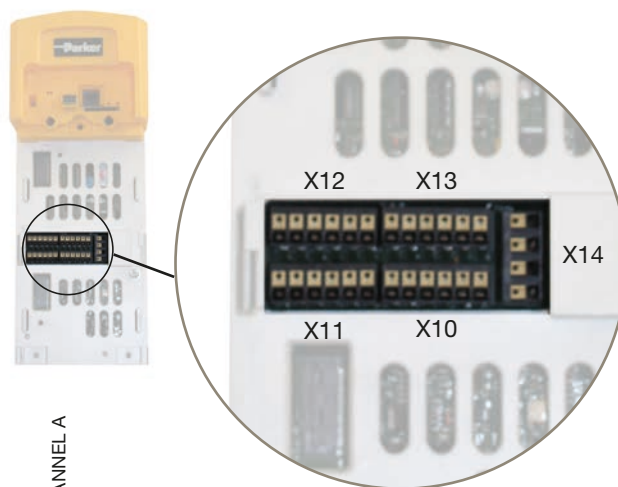

Example, basic speed control wiring diagram



## Accessories and Options

### Operator Keypad

Order Code	Description
7001-00-00	IP54 Graphical keypad
7001-01-00	Keypad blanking cover
LA501991U300	Keypad remote mounting kit (3 m cable and screws)

#### Description:

The backlit LCD graphical keypad can be either mounted locally on the drive or remotely with the use of a remote mounting kit. The keypad has 3 pass code protected user access levels. The keypad can be used to set-up and commission the drive, change parameter settings, monitor running status or diagnose warning or alarm conditions. The display information can be shown in English, German, French, Spanish or Italian.



7001-00-00



7001-01-00

### Data Storage and Cables

Order Code	Description
IF502785	SD card 16GB
CM501989U010	Ethernet cable 1 m
CM501989U011	Ethernet cable 3 m
CM501989U012	Ethernet cable 5 m



IF501990

### Standard Through-Panel Mounting Kits

Order Code	Description
LA502668	Frame D through panel mounting gasket kit
LA502669	Frame E through panel mounting gasket kit
LA502670	Frame F through panel mounting gasket kit
LA502471	Frame G through panel mounting gasket kit
LA502472	Frame H through panel mounting gasket kit
LA502793	Frame J through panel mounting gasket kit

### IP55 Through-Panel Mounting Kits

Order Code	Description
LA503104U001	Frame D through panel mounting gasket & fan kit
LA503104U002	Frame E through panel mounting gasket & fan kit
LA503104U003	Frame F through panel mounting gasket & fan kit
LA503104U004	Frame G through panel mounting gasket & fan kit
LA503104U005	Frame H through panel mounting gasket & fan kit
LA503104U006	Frame J through panel mounting gasket & fan kit

### Cablescreening Kits

Order Code	Description
LA501935U001	Frame D C2 environment filter kit
LA501935U002	Frame E C2 environment filter kit
LA501935U003	Frame F C2 environment filter kit
LA501935U004	Frame G cable screening kit
LA501935U005	Frame H cable screening kit
LA501935U006	Frame J cable screening kit



LA501935U001

The environment filter kit consists of a motor cable ferrite core and screening brackets and is required to comply with the requirements of the EMC directive for a C2 environment with frames D, E and F. For frame G the drive has a different EMC internal filter which is required in addition to the screen kit. For frame H, J and K an external EMC filter is required.

## Communication Interfaces

<b>7003-PB-00</b>	<b>PROFIBUS DP-V1 communication interface</b>
<b>Supported Protocols</b>	PROFIBUS-DP; Demand data and Data exchange
<b>Communication Speed</b>	Up to 12 Mbits/s; automatically detected
<b>Max. number of devices</b>	32 per segment, 126 total
<b>Supported Messages</b>	Up to 152 bytes cyclic I/O, 68 bytes class 1 and 2 acyclic data, 152 bytes configuration data. GSD file provided



<b>7003-DN-00</b>	<b>DeviceNet communication interface</b>
<b>Supported Protocols</b>	DeviceNet protocol (slave)
<b>Communication Speed</b>	125, 250, 500 kbits/s or automatically detected
<b>Max. number of devices</b>	64
<b>Supported Messages</b>	Bit strobed I/O, Polled I/O, Cyclic I/O, Change of state, Explicit messaging



<b>7003-CB-00</b>	<b>CANopen communication interface</b>
<b>Profile</b>	DS301 V4.02
<b>Communication Speed</b>	10 k, 20 k, 50 k, 125 k, 250 k, 500 k, 1 Mbits/s or automatically detected
<b>Max. number of devices</b>	127
<b>Supported Messages</b>	SDO, PDO, NMT, SYNC



<b>7003-PN-00</b>	<b>PROFINET I/O communication interface</b>
<b>Supported Protocols</b>	PROFINET I/O Real-Time (RT) Protocol
<b>Communication Speed</b>	100 Mbits/s full duplex
<b>Max. number of devices</b>	Virtually unlimited
<b>Supported Messages</b>	Up to 256 bytes of cyclic I/O in data in each direction



<b>7003-IP-00</b>	<b>Ethernet IP communication interface</b>
<b>Supported Protocols</b>	Ethernet IP
<b>Communication Speed</b>	10/100 Mbits/s full/half duplex
<b>Max. number of devices</b>	Virtually unlimited
<b>Supported Messages</b>	Up to 256 bytes of consumed data and 256 bytes of produced data, CIP parameter object support, Explicit messaging



<b>7003-RS-00</b>	<b>RS485 / Modbus RTU communication interface</b>
<b>Supported Protocols</b>	Modbus RTU
<b>Communication Speed</b>	1200 to 115200 bits/s
<b>Max. number of devices</b>	247
<b>Supported Messages</b>	Up to 256 bytes of cyclic I/O data in each direction



## Communication Interfaces

<b>7003-BN-00</b>	<b>BACnet MSTP communication interface</b>
<b>Supported Protocols</b>	BACnet/MSTP
<b>Communication Speed</b>	up to 76.8 kbits/s
<b>Max. number of devices</b>	255
<b>Supported Messages</b>	Real time synchronisation according to DM-T S-B, COV notifications and Alarm/Event functionality



<b>7003-BI-00</b>	<b>BACnet/IP communication interface</b>
<b>Supported Protocols</b>	BACnet/IP
<b>Communication Speed</b>	100 Mbits/s
<b>Max. number of devices</b>	255
<b>Supported Messages</b>	Real time synchronisation according to DM-T S-B, COV notifications and Alarm/Event functionality



<b>7003-CN-00</b>	<b>ControlNet communication interface</b>
<b>Supported Protocols</b>	ControlNet
<b>Communication Speed</b>	5 Mbits/s
<b>Max. number of devices</b>	99
<b>Supported Messages</b>	Polled I/O



<b>7003-EC-00</b>	<b>EtherCAT communication interface</b>
<b>Supported Protocols</b>	CANopen over EtherCAT (CoE) DS301 compliant
<b>Communication Speed</b>	100 Mbits/s
<b>Max. number of devices</b>	65534
<b>Supported Messages</b>	SDO, PDO, NMT, SYNC



<b>7003-IM-00</b>	<b>Ethernet TCP communication interface</b>
<b>Supported Protocols</b>	Modbus/TCP
<b>Communication Speed</b>	10/100 Mbits/s
<b>Max. number of devices</b>	Virtually unlimited
<b>Supported Messages</b>	CIP parameter object support, Explicit messaging



## Input and Output Cards

### 7004-01-00 - General Purpose I/O Module

Digital Inputs & Outputs	4x Digital inputs or outputs
Analogue Inputs/Outputs	3x Analogue inputs ( $\pm 10$ V)
Relay Outputs	2x Volt-free relay outputs (230 VAC)
Motor Thermistor Inputs	1x Motor thermistor input
Real time Clock	Included

#### Description:

The general purpose I/O (GPIO) option module can be fitted to all AC30V series drives in the upper I/O option module slot. The modules are field-fittable and offer users the opportunity to expand the drives standard I/O capability, allowing more complex motor control solutions to be implemented.



#### Connection Details:

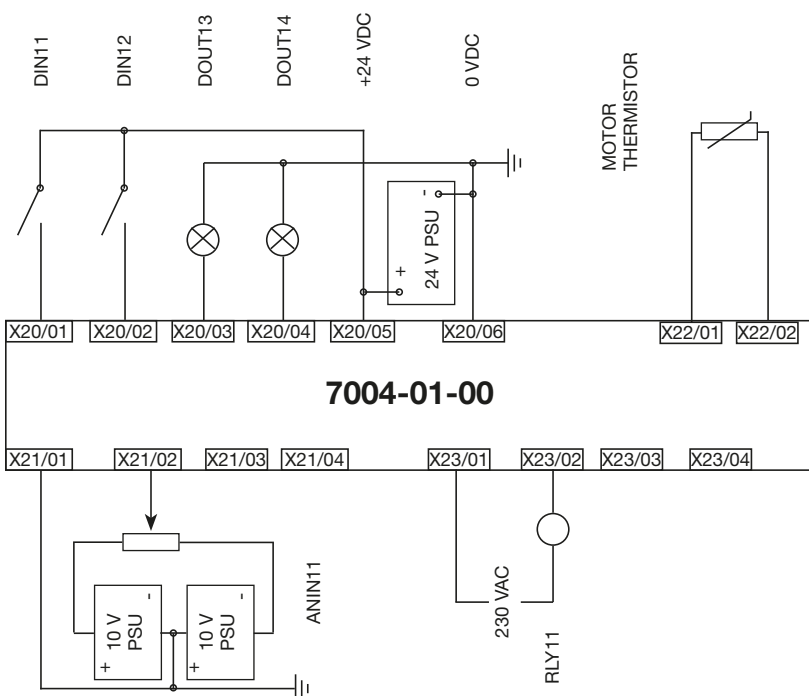

Example connection details for 7004-01-00 GPIO module

Terminal	Label
X20/01	DIN11/DOUT11
X20/02	DIN12/DOUT12
X20/03	DIN13/DOUT13
X20/04	DIN14/DOUT14
X20/05	+24 VDC
X20/06	0 VDC COMMON
X21/01	REFERENCE
X21/02	ANIN11
X21/03	REFERENCE
X21/04	ANIN12
X22/01	MOTOR THERMISTOR
X22/02	MOTOR THERMISTOR
X23/01	RLY11
X23/02	RLY11
X23/03	RLY12
X23/04	RLY12

### 7004-02-00 - Motor Thermistor Input Module

Motor Thermistor Inputs	1x Motor thermistor input
Thermistor Compatibility	PTC, NTC, KTY
Thermistor Resistance Range	0...4.5 k $\Omega$

#### Description:

The isolated motor thermistor input module provides a means of monitoring motor temperature in order to protect the motor from a potentially damaging high temperature.

By default the drive will trip if the motor exceeds a user-defined temperature threshold thereby preventing motor temperature from rising further.



### 7004-03-00 - Real Time Clock and Motor Thermistor Input Module

Motor Thermistor Inputs	1x Motor thermistor input
Thermistor Compatibility	PTC, NTC, KTY
Thermistor Resistance Range	0...4.5 kΩ
Time Format	Seconds
Accuracy (drive powered)	±1 minute / month (RTC trim=0)
Accuracy (drive unpowered)	±5 minutes / month (RTC trim=0)
Battery Backup Duration	6 Months



#### Description:

A real-time clock (RTC) is provided for the user to program the drive to perform functions at specified times. The RTC is battery-backed, so continues to run when the drive is unpowered. The battery recharges when the drive is powered.

An isolated motor thermistor input is also included in the 7004-03-00 module.

### 7004-04-00 - Pulse Encoder Feedback Module

Maximum Input Frequency	250 kHz per channel
Supply Voltage Output	5 V, 12 V, 15 V, 24 V
Input Format	Quadrature, or Clock (inputs A & /A) and Direction (input B & /B)
Motor Thermistor Details	As 7004-02-00



#### Description:

The pulse encoder feedback module allows an incremental encoder to be connected to the AC30 allowing users to take full advantage of the enhanced torque control and speed regulation functionality of the drive. In addition, the 7004-04-00 is also equipped with a single motor thermistor input.

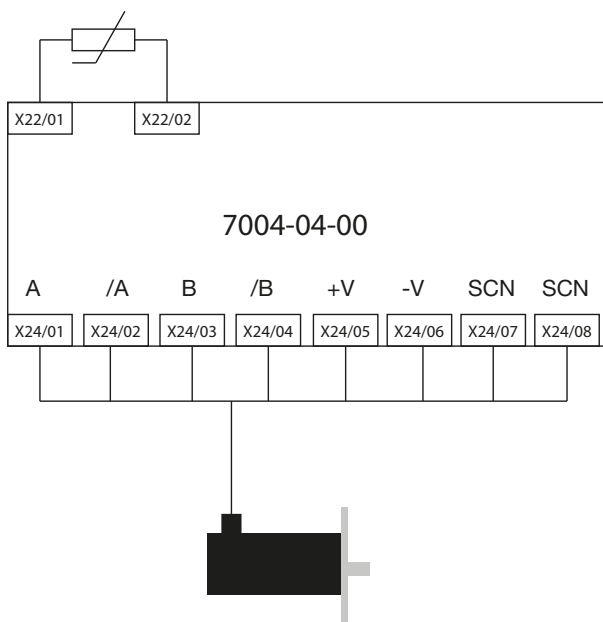

Terminal	Description
X24/01	Channel A
X24/02	Channel /A
X24/03	Channel B
X24/04	Channel /B
X24/05	Supply positive
X24/06	Supply negative
X24/07	Cable screen
X24/08	Cable screen
X22/01	Motor thermistor
X22/02	Motor thermistor

## Ancillary Parts

### Output Chokes

To reduce capacitive currents and prevent nuisance tripping in installations with longer cable runs, a choke may be fitted to the drives output in series with the motor.

Order Code	Motor Power Normal Duty [kW]	Choke Inductance [mH]	Current [A <sub>rms</sub> ]
CO055931	1.1	2	7.5
	1.5		
	2.2		
	3.0		
CO057283	4.0	0.9	22
	5.5		
	7.5		
CO057284	11	0.45	33
	15		
CO057285	18	0.3	44
CO055193	22	50	70
	30		
CO055253	37	50	99
	45		
CO057960	55	50	243
CO0387886	75	50	360



Note 1: For output chokes over 75 kW please contact [ssdedcs@parker.com](mailto:ssdedcs@parker.com)

### EMC Filters

A range of custom designed optional EMC (Electromagnetic Compatibility) filters are available for use with Parker's range of drive products. They are used to help achieve conformance with the EMC directive BS EN 61800-3:2004- "Adjustable speed electrical power drive systems Part 3". These external filters offer C2 compliance to 25m and C1 compliance to 10m.

Order Code	Motor Power Normal Duty [kW]	Frame Size
CO501894	1.1	D
	1.5	D
	2.2	D
	3.0	D
	4.0	D
	5.5	D
	7.5	E
CO501895	11	E
	15	F
	18	F
CO465188U070	22	G
	30	G
CO467842U105	37	G
	45	H
CO467842U215	55	H
	75	H
	90	J
CO502672U320	110	J
	132	J
	160	K



Note 1: For output chokes over 160 kW please contact [ssdedcs@parker.com](mailto:ssdedcs@parker.com)

## Braking Resistors

These resistor sets are designed for stopping the system at rated power. Rated for 10 seconds in a 100 seconds duty cycle. They are metal-clad resistors and should be mounted on a heatsink (back panel) and covered to prevent injury from burning.



### Brake resistor selection

Brake resistor assemblies must be rated to absorb both peak braking power during deceleration and the average power over the complete cycle.

$$\text{Peak braking power} = \frac{0.0055J \times (n_1^2 - n_2^2) \text{ (W)}}{t_b}$$

$$\text{Average braking power } P_{av} = \frac{P_{pk} \times t_b}{t_c}$$

J: total inertia [kgm<sup>2</sup>]  
n<sub>1</sub>: initial speed [min<sup>-1</sup>]  
n<sub>2</sub>: final speed [min<sup>-1</sup>]  
t<sub>b</sub>: braking time [s]  
t<sub>c</sub>: cycle time [s]

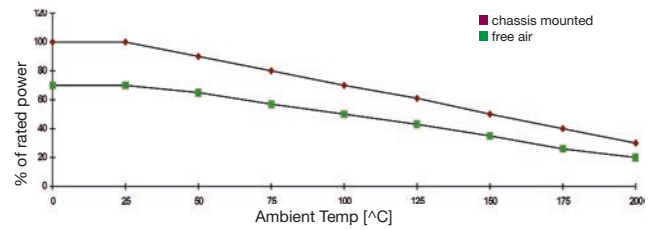

### Resistors above 500 W

Resistors above 500 W are available upon request :

- IP20 protection up to 3 kW
- IP13 protection between 4.2 and 9.8 kW

Model	Impedance [Ω]	Nom. Power [W]	Dimensions [mm]							
			L1	L2	L3	W	H	D	a	b
CZ467715	500	60	100	87	60	22	41	4.3	10	12
CZ467714	200	100	165	152	125	22	41	4.3	10	12
CZ389853	100	100	165	152	125	22	41	4.3	10	12
CZ467717	100	200	165	146	125	30	60	4.3	13	17
CZ463068	56	200	165	146	125	30	60	4.3	13	17
CZ388397	56	200	165	146	125	30	60	4.3	13	17
CZ388396	36	500	335	316	295	30	60	4.3	13	17
CZ467716	28 x 2	500	335	316	295	30	60	4.3	13	17

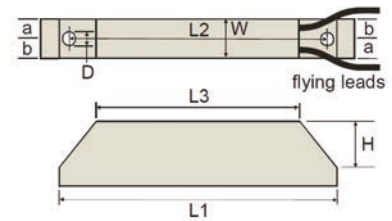

Overload 5 s: 500 %  
Overload 3 s : 833 %  
Overload 1 s: 2500 %

## Parker Drive Quicktool (PDQ) Software

### Description

PDQ is a simple software tool for installing, programming and monitoring applications on the AC30 series variable speed drive.

Communication between the drive and PC is via the in-built Ethernet port at the top of the drive and the software automatically detects all AC30s connected to the Ethernet network.

Once the drive is selected, a simple wizard guides the user through the installation process. Starting with the required application the user is asked to choose their motor data from a motor database or enter their own specific data, to configure the I/O and communications and finally commission the drive. The drive parameters can then be monitored, charted and adjusted.

The drive also supports its own webserver providing access to all drive parameters for quick and easy changes.



Parker Drive Quicktool is shipped with every drive and can also be downloaded for free from the Parker website. [www.parker.com/ssd/pdq](http://www.parker.com/ssd/pdq)

## Parker Drive Developer (PDD) Software

### Description

PDD is a fully featured PLC programming tool for the AC30 series variable speed drive, supporting all IEC-61131 languages including ladder logic, structured text and function block diagrams.

It provides access to all drive parameters and enables the user to create powerful AC30 drive solutions. It's also possible to create custom parameters and menus so the user can describe the setup and status of the drive in the context of their own application.

To help start the development process Parker provides pre-installed libraries with the following functionality:

- Basic Speed Control
- Fan and Pump Control
- Winder Blocks
- Hydraulic Control
- Cascaded Pump Control

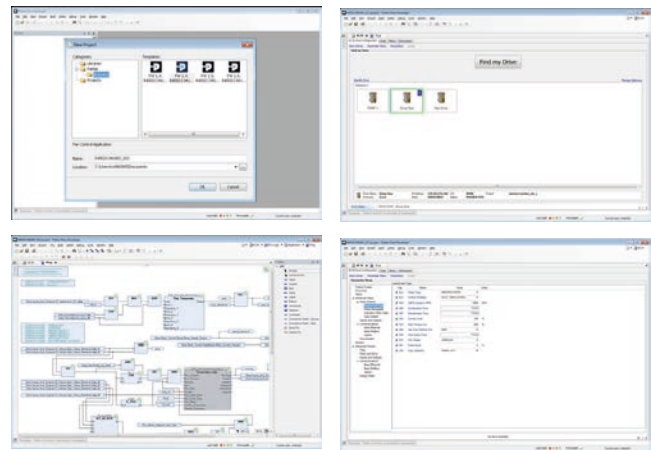



## Order Code

	1	2	3	4	5	6	7	8
Order example	31V	4	D	0004	B	F	T10	M00

<b>1 Device Family</b>	<b>31V</b>	AC30 Series complete drive
	<b>710</b>	Power stack only (no control module)
<b>2 Voltage</b>	<b>4</b>	400 V nominal
<b>3 Frame Size and Current Rating</b>		(normal / heavy duty)
	<b>D0004</b>	1.1 kW / 0.75 kW
	<b>D0005</b>	1.5 kW / 1.1 kW
	<b>D0006</b>	2.2 kW / 1.5 kW
	<b>D0008</b>	3 kW / 2.2 kW
	<b>D0010</b>	4 kW / 3 kW
	<b>D0012</b>	5.5 kW / 4 kW
	<b>E0016</b>	7.5 kW / 5.5 kW
	<b>E0023</b>	11 kW / 7.5 kW
	<b>F0032</b>	15 kW / 11 kW
	<b>F0038</b>	18.5 kW / 15 kW
	<b>G0045</b>	22 kW / 18.5 kW
	<b>G0060</b>	30 kW / 22 kW
	<b>G0073</b>	37 kW / 30 kW
	<b>H0087</b>	45 kW / 37 kW
	<b>H0105</b>	55 kW / 45 kW
	<b>H0145</b>	75 kW / 55 kW
	<b>J0180</b>	90 kW / 75 kW
	<b>J0205</b>	110 kW / 90 kW
	<b>J0260</b>	132 kW / 110 kW
	<b>K0300</b>	160 kW / 132 kW
	<b>K0380</b>	200 kW / 160 kW
	<b>K0440</b>	250 kW / 200 kW

<b>4 Brake Switch <sup>(1)</sup></b>	<b>B</b>	Brake switch fitted (standard)
<b>5 EMC Filter <sup>(2)</sup></b>	<b>N</b>	No filter fitted
	<b>E</b>	Category C3 filter fitted (standard)
	<b>F</b>	Category C2 filter fitted
<b>6 Graphical Keypad</b>	<b>0</b>	No keypad fitted
	<b>1</b>	Blanking cover fitted
	<b>2</b>	Graphical keypad fitted
<b>7 Environmental Coating <sup>(3)</sup></b>	<b>S</b>	Standard 3C3 coating
	<b>E</b>	Enhanced coating
<b>8 Special Options</b>	<b>0000</b>	No special options

- <sup>(1)</sup> Drives include brake switch as standard. For non-brake options please contact [ssdedcs@parker.com](mailto:ssdedcs@parker.com)
- <sup>(2)</sup> The choice of filter should be determined by the environment in which the drive will be installed as defined in IEC/EN61800-3 C2 = domestic & commercial, C3 = industrial
- <sup>(3)</sup> AC30 is conformally coated as standard for use in environments class 3C3 and 3C4 for Hydrogen Sulphide gas. It is also compliant to both classes 3C1 (rural) and 3C2 (urban) for all nine substances defined in table 4 in EN60271-3-3  
C2 filter only offered on frames D-G. For other frames use external EMC filter

### Versatile Control Module

It is possible to order the AC30 Series as a separate power stack and versatile control module. This is useful for distributor or MRO spare part stocking.



Versatile Control Module - 30V-...



Order code 710... Power Stack Only

Order Code	Description
30V-2S-0000	Control module with graphical keypad and standard coating
30V-1S-0000	Control module with blanking cover and standard coating
30V-0S-0000	Control module with standard coating and no graphical keypad
30V-2E-0000	Control module with graphical keypad and enhanced coating
30V-1E-0000	Control module with blanking cover and enhanced coating
30V-0E-0000	Control module with enhanced coating and no graphical keypad

## Accessories

### Graphical Keypad

Order Code	Description
7001-00-00	Graphical keypad for local or remote mounting
7001-01-00	Keypad blanking cover
LA501991U300	Keypad remote mounting kit (3 m cable and screws)

### I/O Options

Order Code	Description
7004-01-00	General purpose I/O module
7004-02-00	Motor thermistor input module
7004-03-00	Real time clock and motor thermistor input module
7004-04-00	Pulse encoder feedback card

### Communication Interfaces

Order Code	Description
7003-PB-00	Profibus DPV1
7003-PN-00	Profinet IO
7003-DN-00	DeviceNet
7003-CN-00	ControlNet
7003-CB-00	CANopen
7003-IP-00	Ethernet IP
7003-IM-00	Ethernet TCP
7003-EC-00	EtherCAT
7003-BI-00	BACnet IP
7003-BN-00	BACnet MSTP
7003-RS-00	RS485/Modbus RTU



# Parker's Motion & Control Technologies

At Parker, we're guided by a relentless drive to help our customers become more productive and achieve higher levels of profitability by engineering the best systems for their requirements. It means looking at customer applications from many angles to find new ways to create value. Whatever the motion and control technology need, Parker has the experience, breadth of product and global reach to consistently deliver. No company knows more about motion and control technology than Parker. For further info call 00800 27 27 5374



## Aerospace

### Key Markets

Aftermarket services  
Commercial transports  
Engines  
General & business aviation  
Helicopters  
Launch vehicles  
Military aircraft  
Missiles  
Power generation  
Regional transports  
Unmanned aerial vehicles

### Key Products

Control systems & actuation products  
Engine systems & components  
Fluid conveyance systems & components  
Fluid metering, delivery & atomization devices  
Fuel systems & components  
Fuel tank inerting systems  
Hydraulic systems & components  
Thermal management  
Wheels & brakes



## Climate Control

### Key Markets

Agriculture  
Air conditioning  
Construction Machinery  
Food & beverage  
Industrial machinery  
Life sciences  
Oil & gas  
Precision cooling  
Process  
Refrigeration  
Transportation

### Key Products

Accumulators  
Advanced actuators  
CO<sub>2</sub> controls  
Electronic controllers  
Filter driers  
Hand shut-off valves  
Heat exchangers  
Hose & fittings  
Pressure regulating valves  
Refrigerant distributors  
Safety relief valves  
Smart pumps  
Solenoid valves  
Thermostatic expansion valves



## Electromechanical

### Key Markets

Aerospace  
Factory automation  
Life science & medical  
Machine tools  
Packaging machinery  
Paper machinery  
Plastics machinery & converting  
Primary metals  
Semiconductor & electronics  
Textile  
Wire & cable

### Key Products

AC/DC drives & systems  
Electric actuators, gantry robots & slides  
Electrohydraulic actuation systems  
Electromechanical actuation systems  
Human machine interface  
Linear motors  
Stepper motors, servo motors, drives & controls  
Structural extrusions



## Filtration

### Key Markets

Aerospace  
Food & beverage  
Industrial plant & equipment  
Life sciences  
Marine  
Mobile equipment  
Oil & gas  
Power generation & renewable energy  
Process  
Transportation  
Water Purification

### Key Products

Analytical gas generators  
Compressed air filters & dryers  
Engine air, coolant, fuel & oil filtration systems  
Fluid condition monitoring systems  
Hydraulic & lubrication filters  
Hydrogen, nitrogen & zero air generators  
Instrumentation filters  
Membrane & fiber filters  
Microfiltration  
Sterile air filtration  
Water desalination & purification filters & systems



## Fluid & Gas Handling

### Key Markets

Aerial lift  
Agriculture  
Bulk chemical handling  
Construction machinery  
Food & beverage  
Fuel & gas delivery  
Industrial machinery  
Life sciences  
Marine  
Mining  
Mobile  
Oil & gas  
Renewable energy  
Transportation

### Key Products

Check valves  
Connectors for low pressure fluid conveyance  
Deep sea umbilicals  
Diagnostic equipment  
Hose couplings  
Industrial hose  
Mooring systems & power cables  
PTFE hose & tubing  
Quick couplings  
Rubber & thermoplastic hose  
Tube fittings & adapters  
Tubing & plastic fittings



## Hydraulics

### Key Markets

Aerial lift  
Agriculture  
Alternative energy  
Construction machinery  
Forestry  
Industrial machinery  
Machine tools  
Marine  
Material handling  
Mining  
Oil & gas  
Power generation  
Refuse vehicles  
Renewable energy  
Truck hydraulics  
Turf equipment

### Key Products

Accumulators  
Cartridge valves  
Electrohydraulic actuators  
Human machine interfaces  
Hybrid drives  
Hydraulic cylinders  
Hydraulic motors & pumps  
Hydraulic systems  
Hydraulic valves & controls  
Hydrostatic steering  
Integrated hydraulic circuits  
Power take-offs  
Power units  
Rotary actuators  
Sensors



## Pneumatics

### Key Markets

Aerospace  
Conveyor & material handling  
Factory automation  
Life science & medical  
Machine tools  
Packaging machinery  
Transportation & automotive

### Key Products

Air preparation  
Brass fittings & valves  
Manifolds  
Pneumatic accessories  
Pneumatic actuators & grippers  
Pneumatic valves & controls  
Quick disconnects  
Rotary actuators  
Rubber & thermoplastic hose & couplings  
Structural extrusions  
Thermoplastic tubing & fittings  
Vacuum generators, cups & sensors



## Process Control

### Key Markets

Alternative fuels  
Biopharmaceuticals  
Chemical & refining  
Food & beverage  
Marine & shipbuilding  
Medical & dental  
Microelectronics  
Nuclear Power  
Offshore oil exploration  
Oil & gas  
Pharmaceuticals  
Power generation  
Pulp & paper  
Steel  
Water/wastewater

### Key Products

Analytical Instruments  
Analytical sample conditioning products & systems  
Chemical injection fittings & valves  
Fluoropolymer chemical delivery fittings, valves & pumps  
High purity gas delivery fittings, valves, regulators & digital flow controllers  
Industrial mass flow meters/controllers  
Permanent no-weld tube fittings  
Precision industrial regulators & flow controllers  
Process control double block & bleeds  
Process control fittings, valves, regulators & manifold valves



## Sealing & Shielding

### Key Markets

Aerospace  
Chemical processing  
Consumer  
Fluid power  
General industrial  
Information technology  
Life sciences  
Microelectronics  
Military  
Oil & gas  
Power generation  
Renewable energy  
Telecommunications  
Transportation

### Key Products

Dynamic seals  
Elastomeric o-rings  
Electro-medical instrument design & assembly  
EMI shielding  
Extruded & precision-cut, fabricated elastomeric seals  
High temperature metal seals  
Homogeneous & inserted elastomeric shapes  
Medical device fabrication & assembly  
Metal & plastic retained composite seals  
Shielded optical windows  
Silicone tubing & extrusions  
Thermal management  
Vibration dampening

# Parker Worldwide

## Europe, Middle East, Africa

**AE – United Arab Emirates, Dubai**  
Tel: +971 4 8127100  
parker.me@parker.com

**AT – Austria, Wiener Neustadt**  
Tel: +43 (0)2622 23501-0  
parker.austria@parker.com

**AT – Eastern Europe, Wiener Neustadt**  
Tel: +43 (0)2622 23501 900  
parker.easteurope@parker.com

**AZ – Azerbaijan, Baku**  
Tel: +994 50 2233 458  
parker.azerbaijan@parker.com

**BE/LU – Belgium, Nivelles**  
Tel: +32 (0)67 280 900  
parker.belgium@parker.com

**BG – Bulgaria, Sofia**  
Tel: +359 2 980 1344  
parker.bulgaria@parker.com

**BY – Belarus, Minsk**  
Tel: +375 17 209 9399  
parker.belarus@parker.com

**CH – Switzerland, Etoy**  
Tel: +41 (0)21 821 87 00  
parker.switzerland@parker.com

**CZ – Czech Republic, Klecany**  
Tel: +420 284 083 111  
parker.czechrepublic@parker.com

**DE – Germany, Kaarst**  
Tel: +49 (0)2131 4016 0  
parker.germany@parker.com

**DK – Denmark, Ballerup**  
Tel: +45 43 56 04 00  
parker.denmark@parker.com

**ES – Spain, Madrid**  
Tel: +34 902 330 001  
parker.spain@parker.com

**FI – Finland, Vantaa**  
Tel: +358 (0)20 753 2500  
parker.finland@parker.com

**FR – France, Contamine s/Arve**  
Tel: +33 (0)4 50 25 80 25  
parker.france@parker.com

**GR – Greece, Athens**  
Tel: +30 210 933 6450  
parker.greece@parker.com

**HU – Hungary, Budaörs**  
Tel: +36 23 885 470  
parker.hungary@parker.com

**IE – Ireland, Dublin**  
Tel: +353 (0)1 466 6370  
parker.ireland@parker.com

**IT – Italy, Corsico (MI)**  
Tel: +39 02 45 19 21  
parker.italy@parker.com

**KZ – Kazakhstan, Almaty**  
Tel: +7 7273 561 000  
parker.easteurope@parker.com

**NL – The Netherlands, Oldenzaal**  
Tel: +31 (0)541 585 000  
parker.nl@parker.com

**NO – Norway, Asker**  
Tel: +47 66 75 34 00  
parker.norway@parker.com

**PL – Poland, Warsaw**  
Tel: +48 (0)22 573 24 00  
parker.poland@parker.com

**PT – Portugal, Leca da Palmeira**  
Tel: +351 22 999 7360  
parker.portugal@parker.com

**RO – Romania, Bucharest**  
Tel: +40 21 252 1382  
parker.romania@parker.com

**RU – Russia, Moscow**  
Tel: +7 495 645-2156  
parker.russia@parker.com

**SE – Sweden, Spånga**  
Tel: +46 (0)8 59 79 50 00  
parker.sweden@parker.com

**SK – Slovakia, Banská Bystrica**  
Tel: +421 484 162 252  
parker.slovakia@parker.com

**SL – Slovenia, Novo Mesto**  
Tel: +386 7 337 6650  
parker.slovenia@parker.com

**TR – Turkey, Istanbul**  
Tel: +90 216 4997081  
parker.turkey@parker.com

**UA – Ukraine, Kiev**  
Tel: +380 44 494 2731  
parker.ukraine@parker.com

**UK – United Kingdom, Warwick**  
Tel: +44 (0)1926 317 878  
parker.uk@parker.com

**ZA – South Africa, Kempton Park**  
Tel: +27 (0)11 961 0700  
parker.southafrica@parker.com

## North America

**CA – Canada, Milton, Ontario**  
Tel: +1 905 693 3000

**US – USA, Cleveland**  
Tel: +1 216 896 3000

## Asia Pacific

**AU – Australia, Castle Hill**  
Tel: +61 (0)2-9634 7777

**CN – China, Shanghai**  
Tel: +86 21 2899 5000

**HK – Hong Kong**  
Tel: +852 2428 8008

**IN – India, Mumbai**  
Tel: +91 22 6513 7081-85

**JP – Japan, Tokyo**  
Tel: +81 (0)3 6408 3901

**KR – South Korea, Seoul**  
Tel: +82 2 559 0400

**MY – Malaysia, Shah Alam**  
Tel: +60 3 7849 0800

**NZ – New Zealand, Mt Wellington**  
Tel: +64 9 574 1744

**SG – Singapore**  
Tel: +65 6887 6300

**TH – Thailand, Bangkok**  
Tel: +662 186 7000

**TW – Taiwan, Taipei**  
Tel: +886 2 2298 8987

## South America

**AR – Argentina, Buenos Aires**  
Tel: +54 3327 44 4129

**BR – Brazil, Sao Jose dos Campos**  
Tel: +55 800 727 5374

**CL – Chile, Santiago**  
Tel: +56 2 623 1216

**MX – Mexico, Toluca**  
Tel: +52 72 2275 4200



### EMEA Product Information Centre

Free phone: 00 800 27 27 5374

(from AT, BE, CH, CZ, DE, DK, EE, ES, FI, FR, IE, IL, IS, IT, LU, MT, NL, NO, PL, PT, RU, SE, SK, UK, ZA)

### US Product Information Centre

Toll-free number: 1-800-27 27 537

www.parker.com