

# TMCM-1278 Hardware Manual

Hardware Version V1.10 | Document Revision V1.20 • 2019-DEC-16

**TMCM-1278 is an easy-to-use, high-power, single axis smart stepper motor driver module.** The module with special housing enclosure is primarily designed for NEMA23/24 size stepper motors. This product is controlled and configured via a CAN bus interface and comes with two firmware options – TMCL and CANopen. TMCM-1278 features StealthChop™ for absolute silent motor control, SpreadCycle™ for high speed stepper motor commutation, a fully integrated hardware motion controller with SixPoint™ motion ramps, as well as StallGuard2™ and CoolStep™.



## Features

- Supply Voltage: +12V to +48V DC
- Current per motor phase: 9A RMS
- CAN bus interface
- TMCL or CANopen protocol
- Integrated SixPoint™ ramp motion controller
- StealthChop™ silent PWM mode
- SpreadCycle™ smart mixed decay
- StallGuard2™ load detection
- CoolStep™ automatic current scaling

## Applications

- Lab-Automation
- Manufacturing
- Robotics
- Factory Automation
- CNC

## Simplified Block Diagram

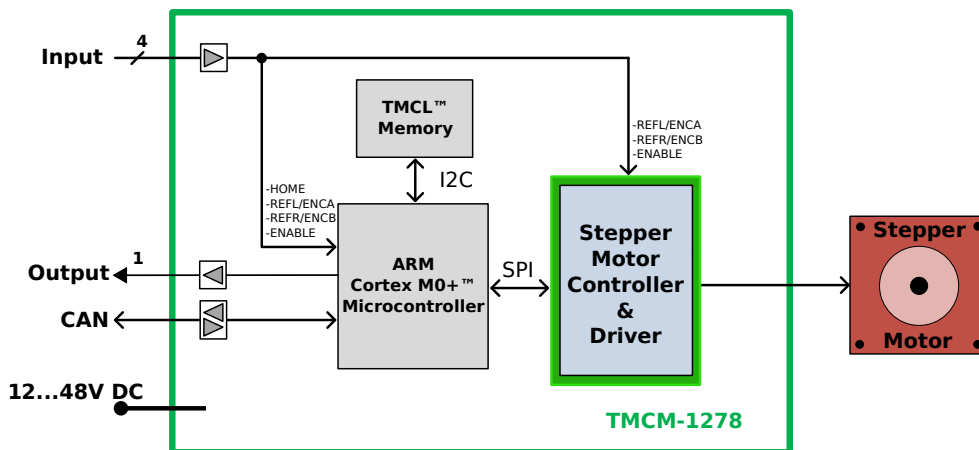

# Contents

<b>1</b>	<b>Features</b>	<b>3</b>
1.1	General Features	3
1.2	TRINAMIC's Unique Features	4
1.2.1	StealthChop™	4
1.2.2	SpreadCycle™	4
1.2.3	StallGuard2™	4
1.2.4	CoolStep™	5
1.2.5	SixPoint™ Motion Controller	5
<b>2</b>	<b>Order Codes</b>	<b>7</b>
<b>3</b>	<b>Mechanical and Electrical Interfacing</b>	<b>8</b>
3.1	TMCM-1278 Dimensions	8
3.2	Mounting Considerations	8
<b>4</b>	<b>Connectors and LEDs</b>	<b>9</b>
4.1	Power Connector	9
4.2	CAN and I/O Connector	10
4.3	Motor Connector	10
4.4	CAN Connection	11
4.5	LEDs	12
<b>5</b>	<b>Functional Description</b>	<b>13</b>
5.1	Typical Application Wiring	13
5.2	Inputs	13
<b>6</b>	<b>Operational Ratings and Characteristics</b>	<b>14</b>
6.1	Absolute Maximum Ratings	14
6.2	Electrical Characteristics (Ambient Temperature 25° C)	14
6.3	I/O Ratings (Ambient Temperature 25° C)	14
6.4	Functional Characteristics	15
6.5	Other Requirements	15
<b>7</b>	<b>Abbreviations used in this Manual</b>	<b>15</b>
<b>8</b>	<b>Figures Index</b>	<b>16</b>
<b>9</b>	<b>Tables Index</b>	<b>17</b>
<b>10</b>	<b>Supplemental Directives</b>	<b>18</b>
10.1	Producer Information	18
10.2	Copyright	18
10.3	Trademark Designations and Symbols	18
10.4	Target User	18
10.5	Disclaimer: Life Support Systems	18
10.6	Disclaimer: Intended Use	18
10.7	Collateral Documents & Tools	19
<b>11</b>	<b>Revision History</b>	<b>20</b>
11.1	Hardware Revision	20
11.2	Document Revision	20



# 1 Features

The TMCM-1278 is a complete stepper driver and controller solution with state of the art feature set. It is highly integrated and offers convenient handling via CAN interface. The TMCM-1278 includes driver electronics and a fully featured hardware motion controller. It can be used in many decentralized applications and has been designed for up to 9A RMS (12.7A peak) phase current and 24V or 48V DC nominal supply voltage. With StealthChop™, the TMCM-1278 offers absolutely silent and smooth motor operation for lower and medium velocities. SpreadCycle™ is a high performance current controlled chopper mode for highest velocities with perfect zero crossing performance. With StallGuard2™, a sensorless load detection feature is available for automatic end step detection and load monitoring. StallGuard2™ is also used for the automatic current scaling feature CoolStep™. The TMCM-1278 comes with a CAN bus interface plus three digital inputs and one digital/analog output.

## 1.1 General Features

### Main Characteristics

- Supply Voltage +24V / +48V nominal (+12V...+48V DC).
- 9A RMS phase current (ca. 12.7A Peak phase current).
- Highest micro step resolution, up to 256 micro steps per full step.
- Permanent onboard parameter storage.
- Advanced SixPoint™ ramp hardware motion controller.
- Noiseless StealthChop™ chopper mode for slow to medium velocities.
- High performance SpreadCycle™ chopper mode.
- High-precision sensorless load measurement with StallGuard2™.
- Automatic current scaling algorithm CoolStep™ to save energy and to keep your drive cool.

### I/Os

- Home input and two reference switch inputs, also usable as general purpose inputs or ABN encoder inputs.
- Enable input to power-on/-off driver H-bridges.
- One general purpose output.

### CAN Bus Interface

- Standard CAN Bus Interface for control and configuration.
- CAN bit rate of 20...1000kBit/s.
- TMCL-based protocol with TMCL firmware option.
- CANopen protocol with DS402 device profile with CANopen firmware option.



## 1.2 TRINAMIC's Unique Features

### 1.2.1 StealthChop™

StealthChop™ is an extremely quiet mode of operation for low and medium velocities. It is based on a voltage mode PWM. During standstill and at low velocities, the motor is absolutely noiseless. Thus, StealthChop™ operated stepper motor applications are very suitable for indoor or home use. The motor operates absolutely free of vibration at low velocities. With StealthChop™, the motor current is applied by driving a certain effective voltage into the coil, using a voltage mode PWM. There are no more configurations required except for the regulation of the PWM voltage to yield the motor target current.

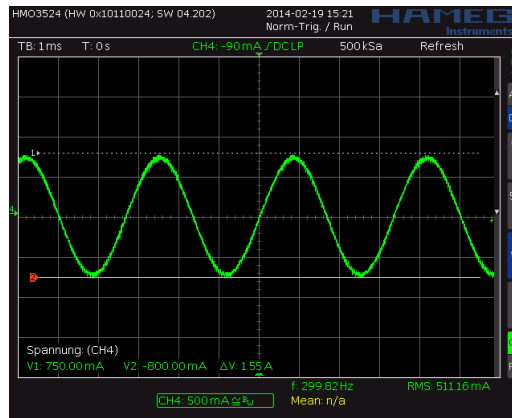

Figure 1: Motor coil sine wave current using StealthChop™ (measured with current probe)

### 1.2.2 SpreadCycle™

The SpreadCycle™ chopper is a high-precision, hysteresis-based, and simple to use chopper mode, which automatically determines the optimum length for the fast-decay phase. Several parameters are available to optimize the chopper to the application. SpreadCycle™ offers optimal zero crossing performance compared to other current controlled chopper algorithms and thereby allows for highest smoothness. The true target current is powered into the motor coils.

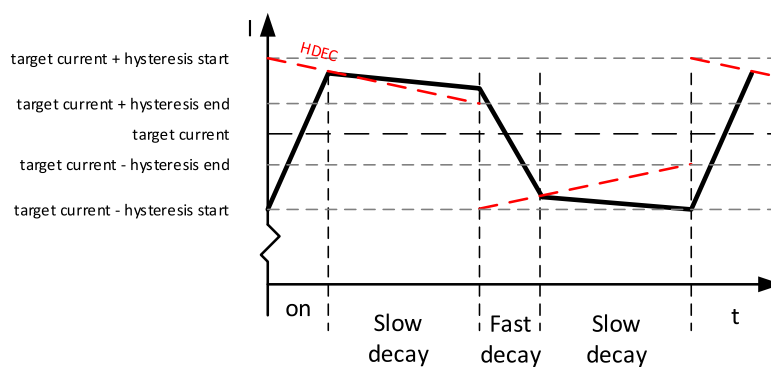

Figure 2: SpreadCycle™ principle

### 1.2.3 StallGuard2™

StallGuard2™ is a high-precision sensorless load measurement using the back EMF of the motor coils. It can be used for stall detection as well as other uses at loads below those which stall the motor. The



StallGuard2™ measurement value changes linearly over a wide range of load, velocity, and current settings. At maximum motor load, the value reaches zero or is near zero. This is the most energy-efficient point of operation for the motor.

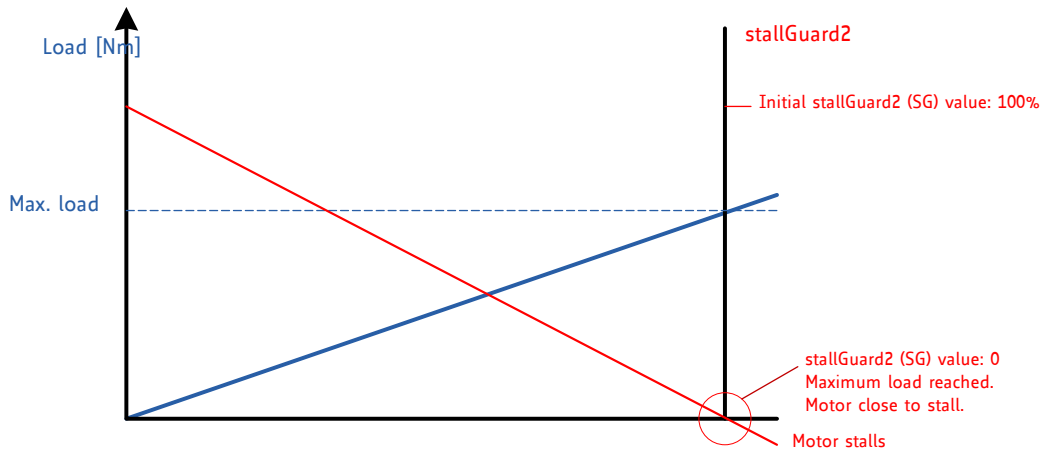

Figure 3: StallGuard2™ Load Measurement as a Function of Load

### 1.2.4 CoolStep™

CoolStep™ is a load-adaptive automatic current scaling based on the load measurement via StallGuard2™. CoolStep™ adapts the required current to the load. Energy consumption can be reduced by as much as 75%. CoolStep™ allows substantial energy savings, especially for motors which see varying loads or operate at a high duty cycle. Because a stepper motor application needs to work with a torque reserve of 30% to 50%, even a constant-load application allows significant energy savings because CoolStep™ automatically enables torque reserve when required. Reducing power consumption keeps the system cooler, increases motor life, and allows for cost reduction.

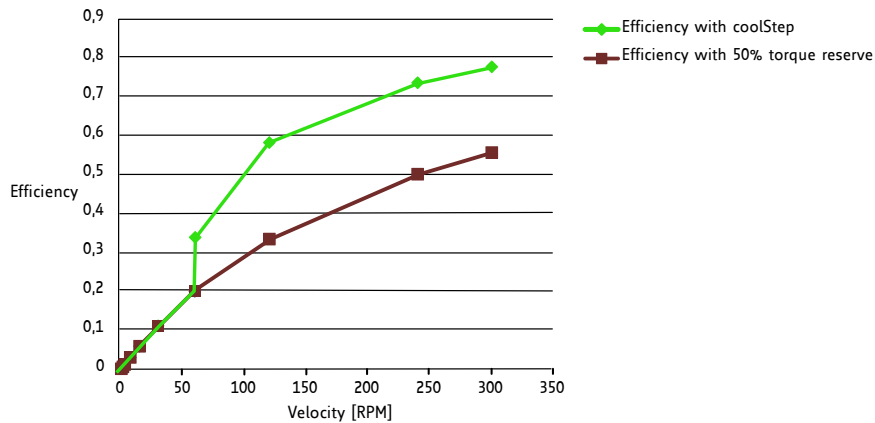

Figure 4: Energy Efficiency Example with CoolStep™

### 1.2.5 SixPoint™ Motion Controller

TRINAMIC's SixPoint™ motion controller is a new type of ramp generator, which offers faster machine operation compared to the classical linear acceleration ramps. The SixPoint™ ramp generator allows adapting the acceleration ramps to the torque curves of a stepper motor and uses two different acceleration settings each for the acceleration phase and for the deceleration phase.



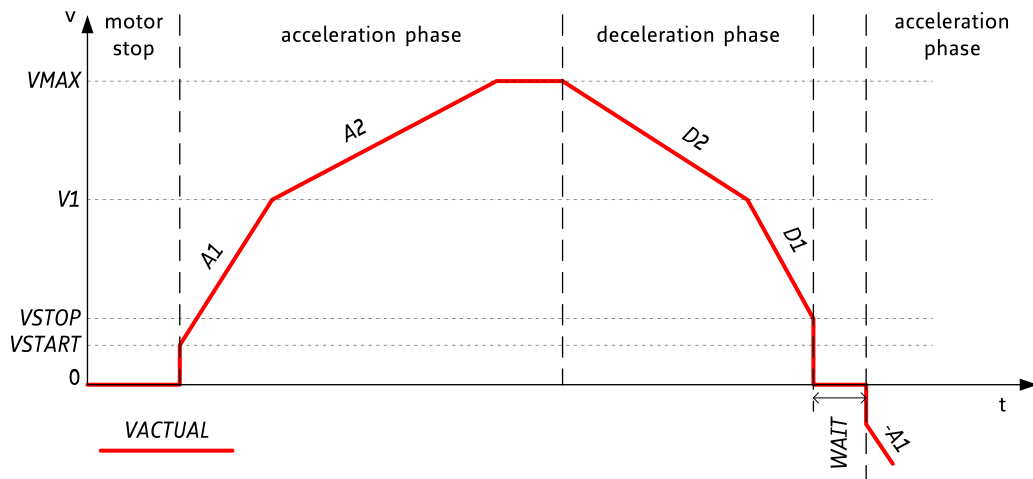

Figure 5: Typical motion profile with TRINAMIC's SixPoint™ motion controller



## 2 Order Codes

Order Code	Description	Size (LxWxH)
TMCM-1278-TMCL	Controller/Driver Module without motor, +12...48V DC, CAN Bus interface, TMCL firmware	60mm x 60mm x 24,5mm
TMCM-1278-CANOpen	Controller/Driver Module without motor, +12...48V DC, CAN Bus interface, CANOpen firmware	60mm x 60mm x 24,5mm

Table 1: Order codes

Order Code	Description
TMCM-1278-CABLE	Cable loom for TMCM-1278: <ul style="list-style-type: none"> <li>• 1x cable loom for power supply connector with 2-pin JST VH series connector</li> <li>• 1x cable loom for motor connector with 4-pin JST VH series connector</li> <li>• 1x cable loom for I/O connector with 8-pin JST EH series connector</li> </ul>

Table 2: Order codes cable loom



### 3 Mechanical and Electrical Interfacing

#### 3.1 TMCM-1278 Dimensions

The dimensions of the TMCM-1278 module are approx. 60mm x 60mm x 24,5mm. There are four mounting holes for M3 screws for mounting the TMCM-1278. These mounting holes are located on the bottom / base plate and accessible after removing the top cover and PCB (see 6, right figure, mounting holes marked red).

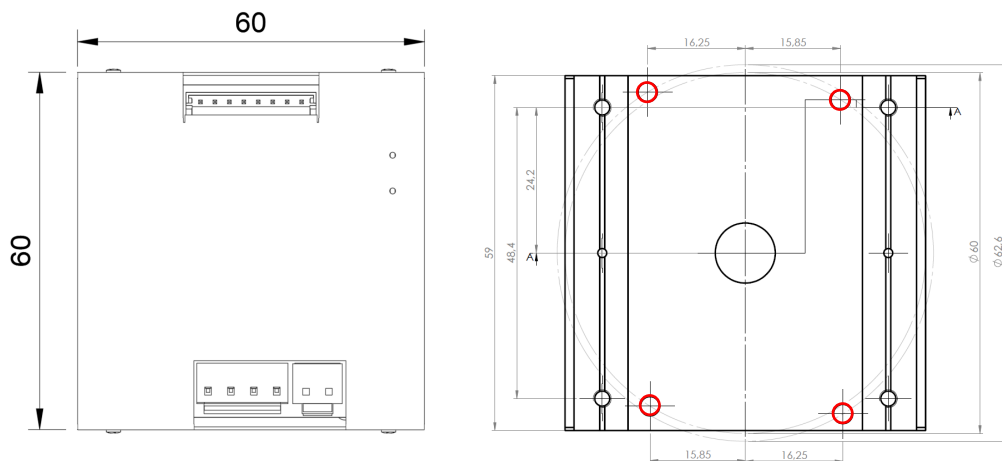

Figure 6: TMCM-1278 top view mechanical dimensions (left) and position of mounting holes (marked red / right). All dimensions in mm

Order Code	Dimension in mm	Weight in g
TMCM-1278	60mm x 60mm x 24,5mm	≈ 70

Table 3: TMCM-1278 dimensions and weight

#### 3.2 Mounting Considerations

TMCM-1278 is designed to be mountable on the back of our NEMA23 and NEMA24 motors. Alternatively, it can be mounted standalone.





## 4 Connectors and LEDs

The TMCM-1278 offers three connectors - one two-pin connector for power supply; one eight-pin connector for communication (CAN) and I/O; one four-pin connector for connecting the motor.

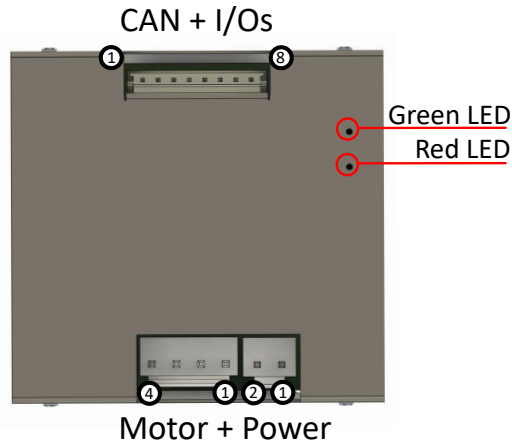

Figure 7: TMCM-1278 connectors

Overview of connector and mating connector types:

Label	Connector type	Mating connector type
Power connector	JST B2P-VH (JST VH series, 2pins, 3.96mm pitch)	Connector housing: JST VHR-2N Contacts: JST SVH-41T-P1.1 Wire: 1.25mm <sup>2</sup> , AWG 16
CAN and I/O connector	JST B8B-EH-A (JST EH series, 8pins, 2.5mm pitch)	Connector housing: JST EHR-8 Contacts: JST SEH-001T-P0.6 Wire: 0.33mm <sup>2</sup> , AWG 22
Motor connector	JST B4P-VH (JST VH series, 4pins, 3.96mm pitch)	Connector housing: JST VHR-4N Contacts: JST SVH-41T-P1.1 Wire: 1.25mm <sup>2</sup> , AWG 16

Table 4: Connector and mating connectors

### 4.1 Power Connector

Pin no.	Pin name	Description
1	GND	Ground
2	+48V	Supply voltage (max. 52V DC)

Table 5: Power Connector



## 4.2 CAN and I/O Connector

Pin no.	Pin name	Description
1	CAN_H	Differential CAN bus signal (non-inverting)
2	CAN_L	Differential CAN bus signal (inverting)
3	GND	Signal ground connection
4	GPO	General purpose output (open drain)
5	HOME (GPIO)	General purpose input 0, can be used as HOME switch input, also. Configurable as analog input AIN0 via software (+5V compatible, internal 10k pull-up to +5V)
6	REFL (GPI1)	General purpose input 1, can be used as left reference / stop switch input REFL / STOP_L, also. Configurable as incremental encoder input channel A via software (+5V TTL compatible, internal 10k pull-up to +5V)
7	REFR (GPI2)	General purpose input 2, can be used as right reference / stop switch input REFR / STOP_R, also. Configurable as incremental encoder input channel B via software (+5V TTL compatible, internal 10k pull-up to +5V)
8	ENN (GPI3)	ENABLE NOT input (active low) for driver stage, 0 = enabled, 1 = disabled (+5V TTL compatible, internal 10k pull-up to +5V)

Table 6: TMCM-1278 I/O connector pin assignment

## 4.3 Motor Connector

Pin no.	Pin name	Description
1	B1	Motor phase B pin 1
2	B2	Motor phase B pin 2
3	A1	Motor phase A pin 1
4	A2	Motor phase A pin 2

Table 7: Motor connector pinning

### NOTICE

**Do not connect or disconnect motor during operation!** Motor cable and motor inductivity might lead to voltage spikes when the motor is connected / disconnected while energized. These voltage spikes might exceed voltage limits of the driver MOSFETs and might permanently damage them. Therefore, always switch off or disconnect power supply before connecting or disconnecting the motor.

### NOTICE

**Always keep the power supply voltage below the upper limit of 52V!** Otherwise the driver electronics will be seriously damaged. Especially, when the selected operating voltage is near the upper limit a regulated power supply is highly recommended.



**NOTICE**

**Add external power supply capacitors!** It is recommended to connect an electrolytic capacitor of significant size (e.g. 4700µF/63V) to the power supply lines next to the TMCM-1278!

Rule of thumb for size of electrolytic capacitor:  $C = \frac{1000\mu F}{A} \times I_{SUPPLY}$

In addition to power stabilization (buffer) and filtering this added capacitor will also reduce any voltage spikes which might otherwise occur from a combination of high inductance power supply wires and the ceramic capacitors. In addition it will limit slew-rate of power supply voltage at the module. The low ESR of ceramic-only filter capacitors may cause stability problems with some switching power supplies.

**NOTICE**

**Tie ENN to GND in order to enable driver stage!** Please note that pin 8 of the Power supply and I/O connector is a driver stage enable input (active low) with an internal pull-up resistor. In order to enable motor driver stage and be able to move the motor using appropriate software commands it is necessary to tie this input to GND.

### 4.4 CAN Connection

For remote control and communication with a host system the TMCM-1278 provides a CAN bus interface. For proper operation the following items should be taken into account when setting up a CAN network:

**Bus Structure** The network topology should follow a bus structure as closely as possible. That is, the connection between each node and the bus itself should be as short as possible. Basically, it should be short compared to the length of the bus.

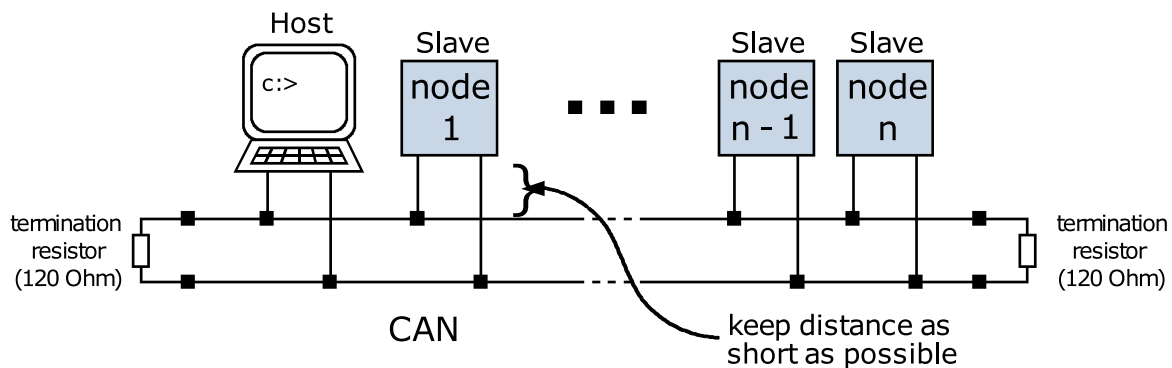

Figure 8: CAN bus structure

**Bus Termination** Especially for longer busses and/or multiple nodes connected to the bus and/or high communication speeds, the bus should be properly terminated at both ends. The TMCM-1278 does not integrate any termination resistor. Therefore, 120 Ohm termination resistors at both ends of the bus have to be added externally.

**Number of Nodes** The bus transceiver used on the TMCM-1278 (TJA1051) supports at least 100 nodes under optimum conditions. Practically achievable number of nodes per CAN bus highly depend on bus length (longer bus → less nodes) and communication speed (higher speed → less nodes).



**CAN Bus Adapters** To quickly connect to the TMCM-1278 a PC based intergated development environment TMCL-IDE is available. Latest release can be downloaded for free from our web site: [www.trinamic.com](http://www.trinamic.com) A number of common CAN interface adapters from different manufactures is supported from within this software. Please make sure to check our web site from time to time for the latest version of the software!

## 4.5 LEDs

The TMCM-1278 includes two LEDs: one green status LED and one red error LED. See figure 9 for LED location.

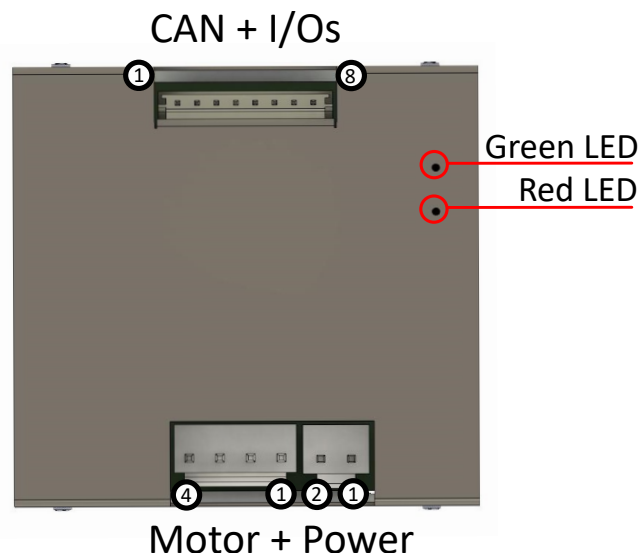

Figure 9: TMCM-1278 LED colors and location

Depending on the firmware option (TMCL or CANopen), these LEDs have different functionality. Main states for TMCL:

State green LED	State red LED	Description TMCL Firmware
Flashing	off	Firmware running (normal operation mode)
Permanent on	Permanent on	Bootloader mode, firmware update supported

Table 8: LED functionality description

For CANopen firmware LED functionality has been implemented based on CANopen standard.



## 5 Functional Description

### 5.1 Typical Application Wiring

The TMCM-1278 driver/controller's wiring is straightforward as shown in the following figure.

- Power supply must be connected to V+ and GND.
- CAN - use appropriate CAN interface adapter
- ENN - connect ENN signal to GND in order to enable driver stage

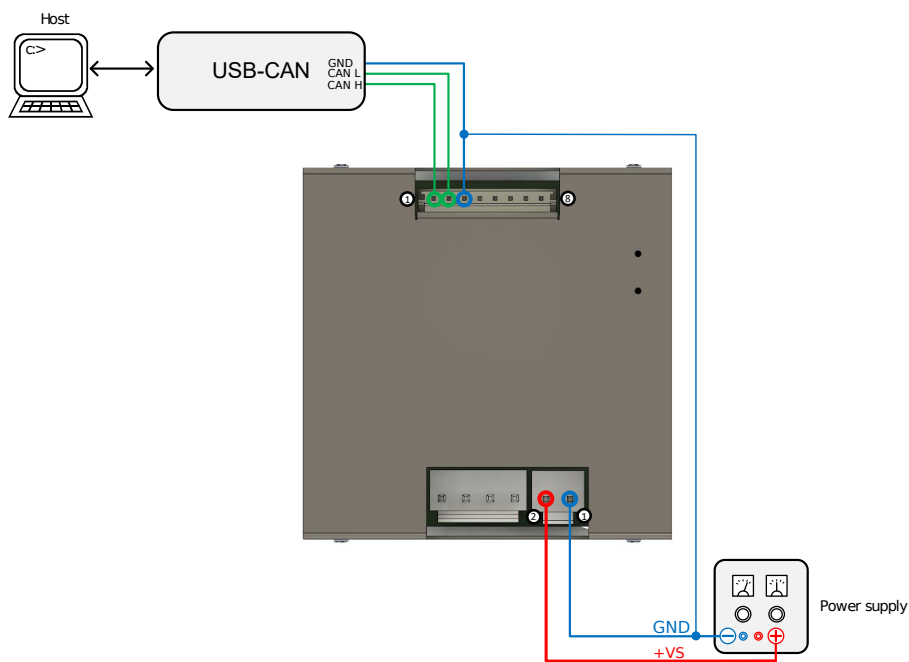

Figure 10: Typical application scenario for remote control of TMCM-1278

### 5.2 Inputs

The three inputs of the TMCM-1278 are +5V TTL compatible with internal pull-ups (4k7) to +5V and not optically isolated.



## 6 Operational Ratings and Characteristics

### 6.1 Absolute Maximum Ratings

Parameter	Min	Max	Unit
Supply voltage	+12	+52	V
Working temperature	-30	+40	° C
Motor coil current / sine wave <b>peak</b>		12.7	A
Continuous motor current ( <b>RMS</b> )		9	A

#### NOTICE

Stresses above those listed under "Absolute Maximum Ratings" may cause permanent damage to the device. This is a stress rating only and functional operation of the device at those or any other conditions above those indicated in the operation listings of this specification is not implied. Exposure to maximum rating conditions for extended periods may affect device reliability.

### 6.2 Electrical Characteristics (Ambient Temperature 25° C)

Parameter	Symbol	Min	Typ	Max	Unit
Supply voltage	$V_{DD}$	12	24 or 48	52	V
Motor coil current / sine wave <b>peak</b> (chopper regulated, adjustable in software)	$I_{COILpeak}$	0		12.7	A
Continuous motor current ( <b>RMS</b> )	$I_{COILRMS}$	0		9	A
Power supply current	$I_{DD}$		$\ll I_{COIL}$	$4.5 * I_{COIL}$	A

Table 10: Electrical Characteristics

Please note: maximum motor current settings may require appropriate cooling of the unit

### 6.3 I/O Ratings (Ambient Temperature 25° C)

Parameter	Symbol	Min	Typ	Max	Unit
Input voltage	$V_{IN}$		5	5.5	V
Low level voltage	$V_L$	0		1.5	V
High level voltage	$V_H$	3.5		5	V
Voltage at open drain output GPO (switched off)	$V_{OUT0}$	0		+30	V
Output sink current of open drain output GPO (switched on)	$I_{OUT0}$	0		100	mA

Table 11: I/O ratings



## 6.4 Functional Characteristics

Parameter	Description / Value
Control	CAN bus interface and four digital inputs for referencing, incremental encoder, and NOT_ENABLE
Communication	CAN bus interface for control and configuration, 20...1000kBit/s
Driving Mode	SpreadCycle™, StealthChop™, and constant $T_{off}$ chopper, adaptive current control via StallGuard2™ and CoolStep™
Stepping Resolution	Full, 1/2, 1/4, 1/8, 1/16, 1/32, 1/64, 1/128, 1/256 step

Table 12: Functional Characteristics

## 6.5 Other Requirements

Specifications	Description or Value
Cooling	Free air
Working environment	Avoid dust, water, oil mist and corrosive gases, no condensation, no frosting
Working temperature	-30° C to +50° C

Table 13: Other Requirements and Characteristics

## 7 Abbreviations used in this Manual

Abbreviation	Description
CAN	Controller Area Network
IDE	Integrated Development Environment
LED	Light Emitting Diode
RMS	Root Mean Square value
TMCL	TRINAMIC Motion Control Language
TTL	Transistor Transistor Logic
UART	Universal Asynchronous Receiver Transmitter
USB	Universal Serial Bus

Table 14: Abbreviations used in this Manual



## 8 Figures Index

1	Motor coil sine wave current using StealthChop™ (measured with current probe) . . . . .	4	6	TMCM-1278 top view mechanical dimensions (left) and position of mounting holes (marked red / right). All dimensions in mm . . . . .	8
2	SpreadCycle™ principle . . . . .	4	7	TMCM-1278 connectors . . . . .	9
3	StallGuard2™ Load Measurement as a Function of Load . . . . .	5	8	CAN bus structure . . . . .	11
4	Energy Efficiency Example with CoolStep™ . . . . .	5	9	TMCM-1278 LED colors and location . . . . .	12
5	Typical motion profile with TRINAMIC's SixPoint™ motion controller . . . . .	6	10	Typical application scenario for remote control of TMCM-1278 . . . . .	13





## 9 Tables Index

1	Order codes . . . . .	7	8	LED functionality description . . . . .	12
2	Order codes cable loom . . . . .	7	10	Electrical Characteristics . . . . .	14
3	TMC-1278 dimensions and weight . . . . .	8	11	I/O ratings . . . . .	14
4	Connector and mating connectors . . . . .	9	12	Functional Characteristics . . . . .	15
5	Power Connector . . . . .	9	13	Other Requirements and Characteristics . . . . .	15
6	TMC-1278 I/O connector pin assignment . . . . .	10	14	Abbreviations used in this Manual . . . . .	15
7	Motor connector pinning . . . . .	10	15	Hardware Revision . . . . .	20
			16	Document Revision . . . . .	20



## 10 Supplemental Directives

### 10.1 Producer Information

### 10.2 Copyright

TRINAMIC owns the content of this user manual in its entirety, including but not limited to pictures, logos, trademarks, and resources. © Copyright 2019 TRINAMIC. All rights reserved. Electronically published by TRINAMIC, Germany.

Redistributions of source or derived format (for example, Portable Document Format or Hypertext Markup Language) must retain the above copyright notice, and the complete Datasheet User Manual documentation of this product including associated Application Notes; and a reference to other available product-related documentation.

### 10.3 Trademark Designations and Symbols

Trademark designations and symbols used in this documentation indicate that a product or feature is owned and registered as trademark and/or patent either by TRINAMIC or by other manufacturers, whose products are used or referred to in combination with TRINAMIC's products and TRINAMIC's product documentation.

This Hardware Manual is a non-commercial publication that seeks to provide concise scientific and technical user information to the target user. Thus, trademark designations and symbols are only entered in the Short Spec of this document that introduces the product at a quick glance. The trademark designation /symbol is also entered when the product or feature name occurs for the first time in the document. All trademarks and brand names used are property of their respective owners.

### 10.4 Target User

The documentation provided here, is for programmers and engineers only, who are equipped with the necessary skills and have been trained to work with this type of product.

The Target User knows how to responsibly make use of this product without causing harm to himself or others, and without causing damage to systems or devices, in which the user incorporates the product.

### 10.5 Disclaimer: Life Support Systems

TRINAMIC Motion Control GmbH & Co. KG does not authorize or warrant any of its products for use in life support systems, without the specific written consent of TRINAMIC Motion Control GmbH & Co. KG.

Life support systems are equipment intended to support or sustain life, and whose failure to perform, when properly used in accordance with instructions provided, can be reasonably expected to result in personal injury or death.

Information given in this document is believed to be accurate and reliable. However, no responsibility is assumed for the consequences of its use nor for any infringement of patents or other rights of third parties which may result from its use. Specifications are subject to change without notice.

### 10.6 Disclaimer: Intended Use

The data specified in this user manual is intended solely for the purpose of product description. No representations or warranties, either express or implied, of merchantability, fitness for a particular purpose



or of any other nature are made hereunder with respect to information/specification or the products to which information refers and no guarantee with respect to compliance to the intended use is given.

In particular, this also applies to the stated possible applications or areas of applications of the product. TRINAMIC products are not designed for and must not be used in connection with any applications where the failure of such products would reasonably be expected to result in significant personal injury or death (safety-Critical Applications) without TRINAMIC's specific written consent.

TRINAMIC products are not designed nor intended for use in military or aerospace applications or environments or in automotive applications unless specifically designated for such use by TRINAMIC. TRINAMIC conveys no patent, copyright, mask work right or other trade mark right to this product. TRINAMIC assumes no liability for any patent and/or other trade mark rights of a third party resulting from processing or handling of the product and/or any other use of the product.

## 10.7 Collateral Documents & Tools

This product documentation is related and/or associated with additional tool kits, firmware and other items, as provided on the product page at: [www.trinamic.com](http://www.trinamic.com).



## 11 Revision History

### 11.1 Hardware Revision

Version	Date	Author	Description
1.00	2019-APR-05	TMC	First Prototypes.
1.10	2019-AUG-05	TMC	First series release.

*Table 15: Hardware Revision*

### 11.2 Document Revision

Version	Date	Author	Description
1.10	2019-AUG-26	HH	Small update for first release.
1.20	2019-DEC-16	GE	Minor updates

*Table 16: Document Revision*

