

# stepper motors



gear box

brake

encoder

up to IP68

special versions

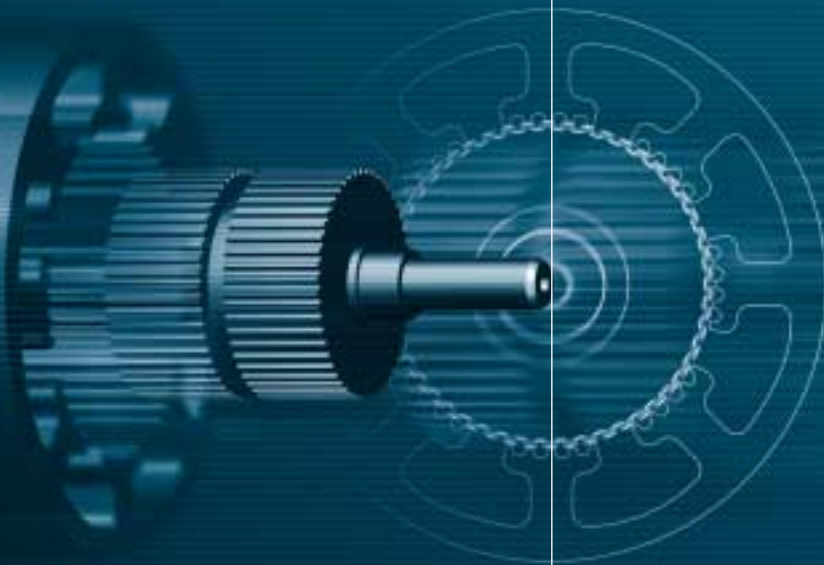

[www.stoegra.de](http://www.stoegra.de)

**stögra**  
ANTRIEBSTECHNIK GMBH



driving

motion control

positioning

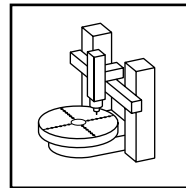
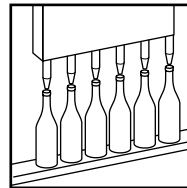
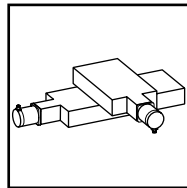
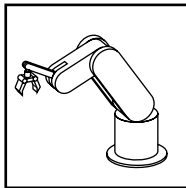
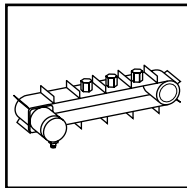
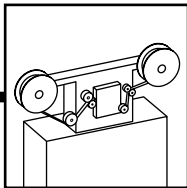

## STÖGRA Antriebstechnik GmbH

Blieskastelstraße 5

D-81379 München

Tel: +49 89 15 90 40 00

Fax: +49 89 15 90 40 09

E-Mail: [info@stoegra.de](mailto:info@stoegra.de)

Internet: <http://www.stoegra.de>

All rights reserved

Without written approval we don't allow reprint or partial copying.

We reserve the right to make engineering changes, refinements and improvements to all products described herein.

Mechanical and electrical ratings and dimensions are, therefore, subject to change without notice.

No liability whatsoever is accepted.

Edition January 2016

ordering key	4
dimensions standard type	5
keyways and woodruffs	6
overview electrical and mechanical specifications	7
<b>max. operating torque</b>	
series SM 56	8
series SM 87	10
series SM 88	12
series SM 107	14
series SM 87 with WSE xx.230AC – 320VDC (230VAC)	16
series SM 88 with WSE xx.230AC – 320VDC (230VAC)	17
serie SM 107 with WSE xx.230AC – 320VDC (230VAC)	18
series SM 168	19
stepper motor phase current characteristics	20
<b>hollow shaft motors</b>	
series SMH 88	21
series SMH 107	21
<b>stepper motor connections</b>	
standard stepper motor connections SM 87, SM 88, SM 107	22
standard stepper motor connections SM 56 and H200/H500	23
<b>stepper motors with connectors</b>	
stepper motor with connections via circular connectors M23 – series SM ...X and SM ...Y	24
stepper motor with connections via connector Mil-C-5015 – option Z257	26
stepper motor with connections via D-Sub connector – options Z154, Z159 and Z182	26
<b>stepper motors – special versions</b>	
stepper motor with extended operating temperature – options Z80 and Z240	27
shaft diameter options for SM 87 and SM 88 – options Z8 and Z200	27
metallic back cover for SM 87, SM 88 and SM 107 – option Z48	27
vacuum compatible stepper motors serie SM ...V and SM ...V Z138	27
stepper motors with protection class IP68 – Z9 and Z177	28
stepper motors with special coating – Z119 and Z177	28
table step motors – controls / drives	29
<b>stepper motor equipment</b>	
overview: stepper motor with gear, encoder and brake	30
<b>planetary gear head</b>	
stepper motor with planetary gear head series SM 56 PE	31
stepper motor with planetary gear head series SM 56 PRA	32
stepper motor with planetary gear head series SM 56 PR	33
stepper motor with planetary gear head series SM 87 PE / SM 88 PE	34
stepper motor with planetary gear head series SM 87 PR / SM 88 PR	35
stepper motor with planetary gear head series SM107 PE	36
stepper motor with planetary gear head series SM107 PR	37
<b>integrated encoder</b>	
stepper motor with integrated encoder E50	38
stepper motor with integrated encoder H200 und H500	39
stepper motor with brake	40
dimensions stepper motor with gear, encoder and brake	41
cable glands	41

# 4 ordering Key

**STÖGRA Stepper motors** are designed as modular system. This enables us to provide a great variety of standard motor types and a high flexibility for customer specific solutions.

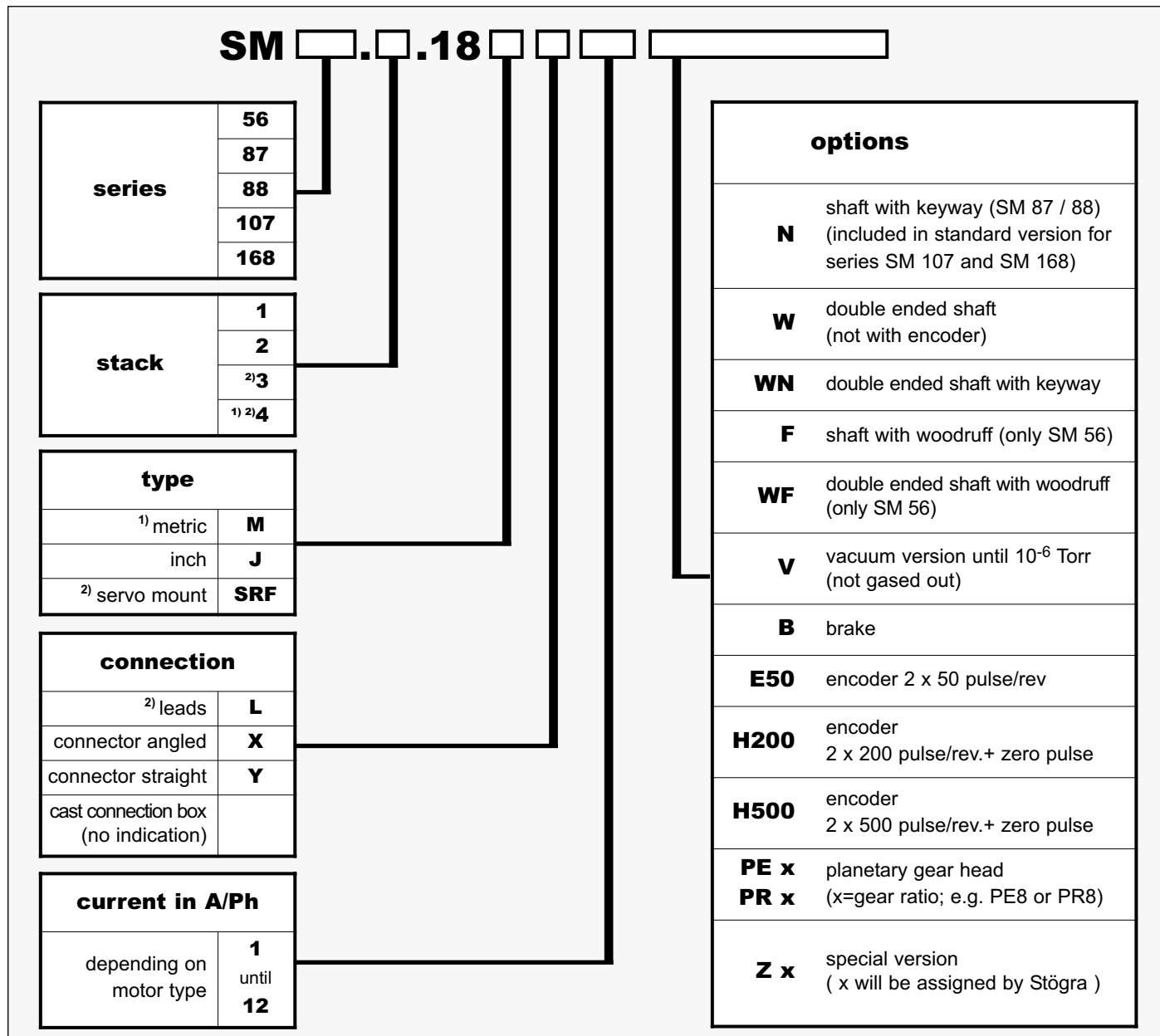

<sup>1)</sup> not for series 56      <sup>2)</sup> not for series 168

**Please note, not all options can be combined!**

SM 86 series is replaced by SM 87 series, SM 108 and SM 109 series is replaced by SM 107 series.

**Cable glands are not included in standard motor deliveries!** Cable glands must be ordered seperately. (See page 39)

**Counter connectors are not included for motors with connectors!** Counter connectors must be ordered seperately. (See page 22)

<p><b>general STÖGRA motor specifications:</b></p> <ul style="list-style-type: none"> <li>▪ ± 3% accuracy based on 1.8° motor step angle (non cumulative)</li> <li>▪ operating temperature -30°C until 80°C (short time until 100°C) for standard types</li> <li>▪ insulation class F according to VDE 0530</li> <li>▪ dielectric motor strength 1800 vrms (series 56: 1000 vrms)</li> <li>▪ high bearing thrust and overhang loads</li> <li>▪ RoHs conform directive to 2002/95/EC</li> <li>▪ Protection class: IP55: with cast connection box / IP41: with leads / IP68: in special versions</li> </ul>	<p><b>order examples:</b></p> <p>SM 56.2.18J3E50 PE8                  SM 87.1.18ML3                  SM 88.3.18MX8BH200                  SM 107.2.18M12BE50 PE4                  SM 168.2.18M12</p>
---	---

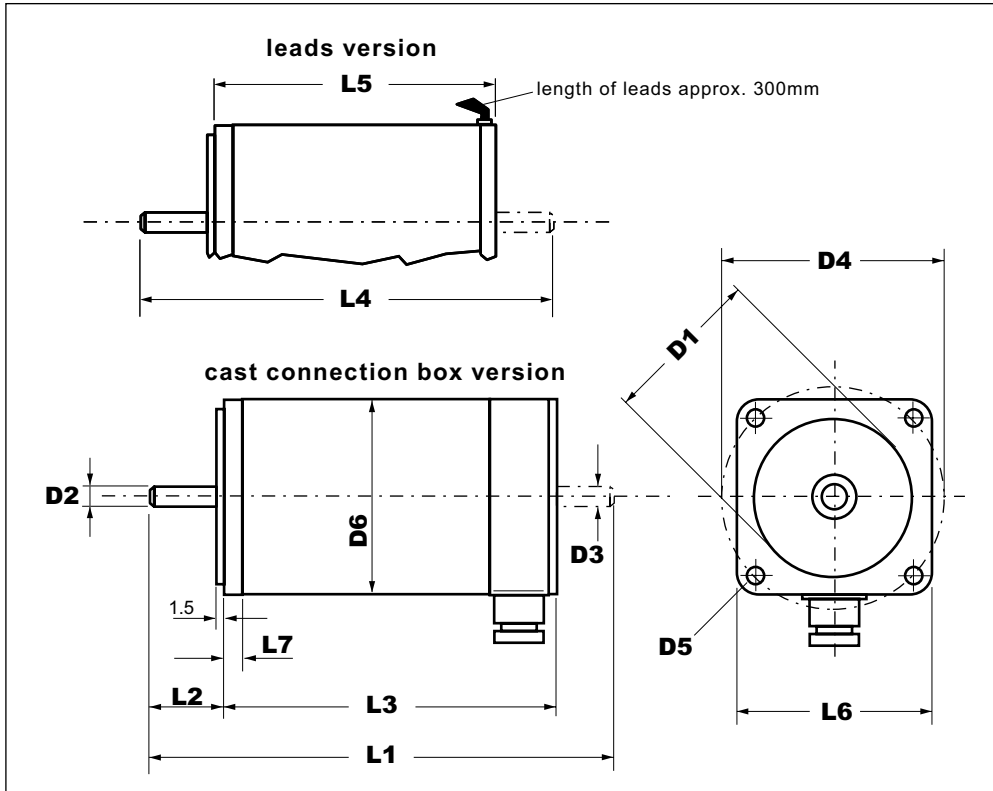

stepping motor		D1 -0.05		D2 -0.02		D3 -0.02		D4		D5	D6	L1	L2	L3	L4	L5	L6	L7	thread of cable entry
series	type	M	J	M	J	M	J	M	J				+0.5	±0.5		±0.5			
56	SM 56.1.18											108		76	90	50			M20 x 1.5
	SM 56.2.18		38.1		6.35		6.35		66.5	5.3	56.5	134	21	102	116	76	56.5	5	
	SM 56.3.18											162		130	144	104			
87	SM 87.1.18											137		85.5	137	60.5			M20 x 1.5
	SM 87.2.18		73	10	9.52	10	9.52	99	6.5	86	169	31.5	117.5	169	92.5	86	5.5		
	SM 87.3.18			(12) <sup>1)</sup>		(12) <sup>1)</sup>					201		149.5	201	124.5				
	SM 87.4.18										233		181.5	233	156.5				
88	SM 88.1.18				9.52							145		93.5	145	68.5			M20 x 1.5
	SM 88.2.18		73	12		12	9.52	99	6.5	86	177	31.5	125.5	177	100.5	86	7		
	SM 88.3.18			(10) <sup>1)</sup>		(10) <sup>1)</sup>					209		157.5	209	132.5				
	SM 88.4.18										241		189.5	241	164.5				
107	SM 107.1.18			12	12.7							170	32	111		89.5			M20 x 1.5
	SM 107.2.18		60	55.54		10					238		161		139.5	108	9		
	SM 107.3.18			16	15.87		12.7	127.5	125.5	8.5	108	288	50	211		189.5			
	SM 107.4.18					12					338		261		239.5				
168	SM 168.1.18		180		24		19		215	15	168	268	50.5	179			192	17	M20 x 1.5
	SM 168.2.18										343		254						

all dimensions in mm

<sup>1)</sup> series SM87 also available as special version with 12 mm shaft and series SM88 also available with 10 mm shaft

M = metric

J = inch

## 6 keyways and woodruffs

### keyways:

Series SM 107 and SM 168 are delivered in standard version with keyway (but not on double ended shaft).  
At series SM 87 the keyway is an option, which has to be indicated at the ordering key.

keyway DIN 6885 T1		stepping motor				keyway DIN 6885 T1		
		series	type	M	J	SRF	type A b x h x l	a
	56	SM 56.1.18	/	0	0	A2 x 2 x 12	3	3
		SM 56.2.18						
		SM 56.3.18						
	87	SM 87.1.18	0	0	0	until Ø10 A3 x 3 x 15 from Ø12 A4 x 4 x 15	6	1.5
		SM 87.2.18						
		SM 87.3.18						
		SM 87.4.18						
	88	SM 88.1.18	0	0	0	until Ø10 A3 x 3 x 15 from Ø12 A4 x 4 x 15	6	1.5
		SM 88.2.18						
		SM 88.3.18						
		SM 88.4.18						
	107	SM 107.1.18	S	S	/	A5 x 5 x 20	5	5
SM 107.2.18								
SM 107.3.18								
SM 107.4.18								
168	SM 168.1.18	S	/	/	A8 x 7 x 25	5	5	
	SM 168.2.18							

<sup>1)</sup>double ended shaft

woodruff DIN 6888		stepping motor				woodruff DIN 6888		
		series	type	J	SRF	type s x h	d	c
	56	SM 56.1.18	0	0	2 x 2.6	7	7	1.8
		SM 56.2.18						
		SM 56.3.18						

/ = no standard stepping motor

S = standard – stepping motor is delivered with keyway in standard version

O = option – stepping motor is delivered without keyway or woodruff in standard version

### order examples:

- SM 56.2.18J3F with woodruff
- SM 87.2.18M6N with keyway at front shaft
- SM 87.2.18M6WN with keyway only at double ended shaft
- SM 87.2.18M6NWN with keyway at front and double ended shaft

overview electrical and mechanical specifications **7**

weight and rotor inertia are for standard versions with cast connection box without double ended shaft		electrical specifications				mechanical specifications						
		resistance per phase	inductance / phase	current / phase unipolar	current / phase bipolar	step angle (at full step)	holding torque	detent torque	rotor inertia	bearing thrust load	bearing over-hang load	weight
series	motor type	Ohm	mH	A	A	°	Nm	Nm	kgcm <sup>2</sup>	N	N	kg
56	SM 56.1.18 J1	4.75	9	1	1.4	1.8	0.45	0.04	0.125	80	150	0.6
	SM 56.1.18 J3	0.72	1	3	4.2							
	SM 56.1.18 J3.9	0.42	0.64	3.9	5.5							
	SM 56.2.18 J1.5	3.9	9	1.5	2.1	1.8	0.85	0.08	0.25	80	150	1
	SM 56.2.18 J2	2.6	5	2	2.8							
	SM 56.2.18 J3	1.2	2.6	3	4.2							
	SM 56.3.18 J1.5	4.3	9	1.5	2.1	1.8	1.25	0.12	0.375	80	150	1.35
	SM 56.3.18 J3	1.46	3	3	4.2							
SM 56.3.18 J4.6	0.72	1.2	4.6	6.5								
87	SM 87.1.18 M1.6	2.9	6	1.6	2.3	1.8	1.8	0.08	0.65	180	280	1.7
	SM 87.1.18 M3	0.72	1.6	3	4.2							
	SM 87.1.18 M5	0.28	0.7	5	7							
	SM 87.2.18 M3.5	0.74	3	3.5	5	1.8	3.6	0.16	1.3	180	280	2.65
	SM 87.2.18 M4.6	0.48	1.5	4.6	6.5							
	SM 87.2.18 M6	0.38	1	6	8.4							
	SM 87.3.18 M3.5	1.1	5	3.5	5	1.8	5.4	0.24	1.95	180	280	3.65
	SM 87.3.18 M6	0.43	1.7	6	8.4							
	SM 87.3.18 M7	0.33	1	7	10							
	SM 87.4.18 M6	0.55	2.3	6	8.4							
SM 87.4.18 M7	0.42	1.8	7	10	1.8	7.2	0.32	2.6	180	280	4.6	
88 <sup>1)</sup>	SM 88.1.18 M2	1.88	11.1	-	2	1.8	3	0.12	1.35	180	280	1.9
	SM 88.1.18 M4	0.5	2.5	-	4							
	SM 88.1.18 M8	0.13	0.75	-	8							
	SM 88.2.18 M2	3.61	26	-	2	1.8	6	0.24	2.7	180	280	2.85
	SM 88.2.18 M4	0.74	5.5	-	4							
	SM 88.2.18 M8	0.21	1.5	-	8							
	SM 88.3.18 M4	1.14	10.9	-	4	1.8	9	0.36	4.05	180	280	3.85
	SM 88.3.18 M8	0.29	2.6	-	8							
	SM 88.3.18 M12	0.14	1	-	12							
	SM 88.4.18 M4					1.8	12	0.48	5.4	180	280	4.8
SM 88.4.18 M8	0.37	3.55	-	8								
SM 88.4.18 M12	0.12	1.75	-	12								
107	SM 107.1.18 M4 <sup>1)</sup>	0.45	4.8	-	4	1.8	5	0.2	4	400	650	4.3
	SM 107.1.18 M6	0.3	1.6	5	7							
	SM 107.1.18 M8	0.225	1.2	5.7	8							
	SM 107.1.18 M12	0.1	0.55	8.8	12.5							
	SM 107.2.18 M4 <sup>1)</sup>	0.76	9.6	-	4	1.8	9	0.4	8	400	650	7.2
	SM 107.2.18 M8	0.38	2.4	5.7	8							
	SM 107.2.18 M10	0.25	1.6	7.1	10							
	SM 107.2.18 M12	0.175	1.15	8.8	12.5							
	SM 107.3.18 M6 <sup>1)</sup>	0.56	7.6	-	6	1.8	13	0.6	12	400	650	9.8
	SM 107.3.18 M10	0.38	2.7	7.1	10							
	SM 107.3.18 M12	0.28	1.9	8.8	12.5							
	SM 107.4.18 M6 <sup>1)</sup>	0.68	10.8	-	6	1.8	17	0.8	16	400	650	12.5
SM 107.4.18 M12	0.34	2.7	8.8	12.5								
168	SM 168.1.18 M12	0.18	2.5	8.8	12.5	1.8	19	0.3	31.2	660	1000	18
	SM 168.2.18 M12	0.28	5	8.8	12.5	1.8	38	0.6	64.4	660	1000	23

<sup>1)</sup> only with bipolar winding in standard version

# 8 max. operating torque series SM 56



SM 168      SM 107      SM 87/88      **SM 56**

All printed torque performance curves are measured with **STÖGRA drives**.

- measured with 30 VDC
- - - - - measured with 60 VDC
- ..... without boost

## SM 56.1.18J1

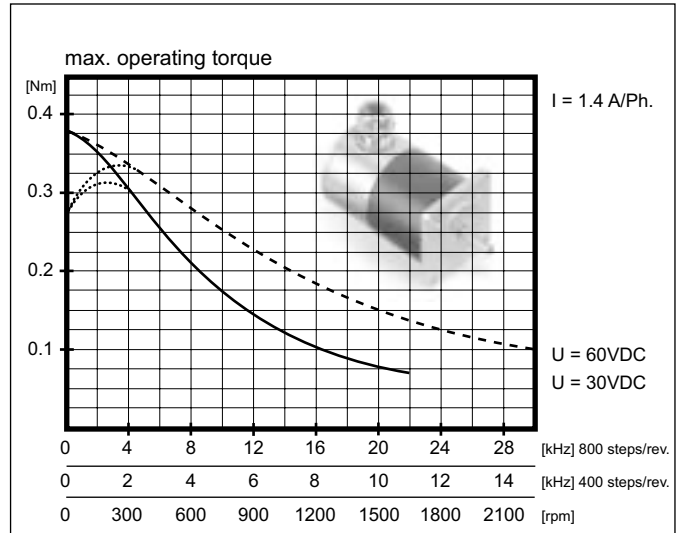

## SM 56.2.18J1.5

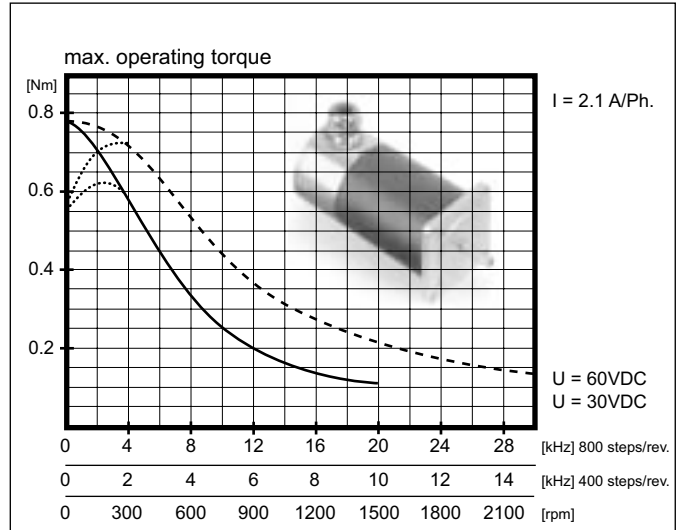

## SM 56.3.18J1.5

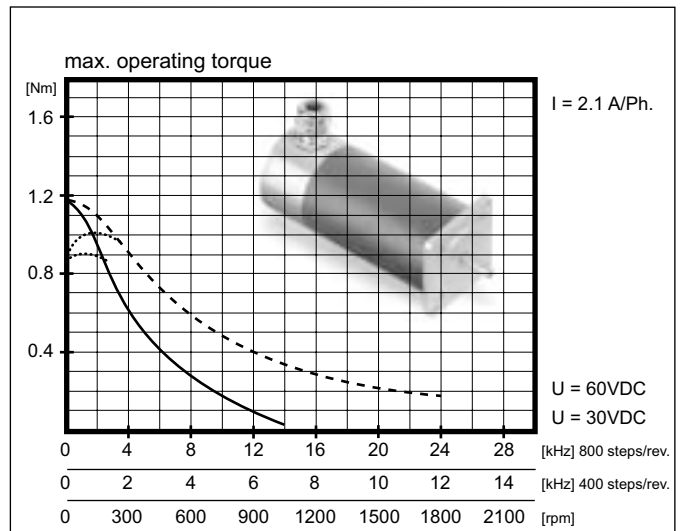



**SM 56.1.18J3**

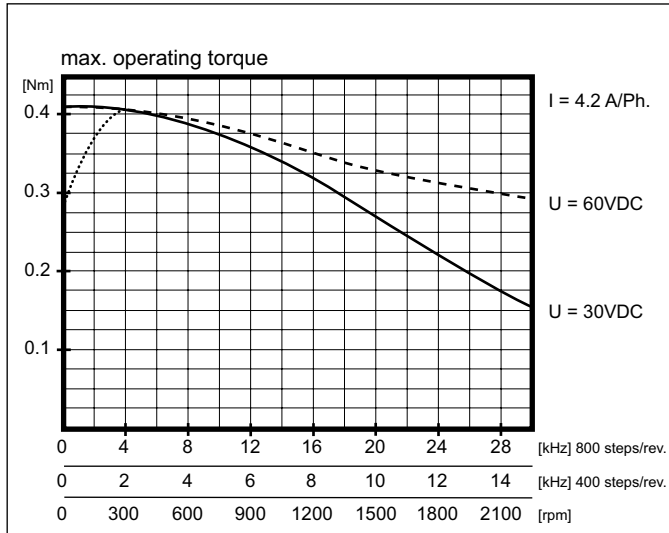

**SM 56.1.18J3.9**

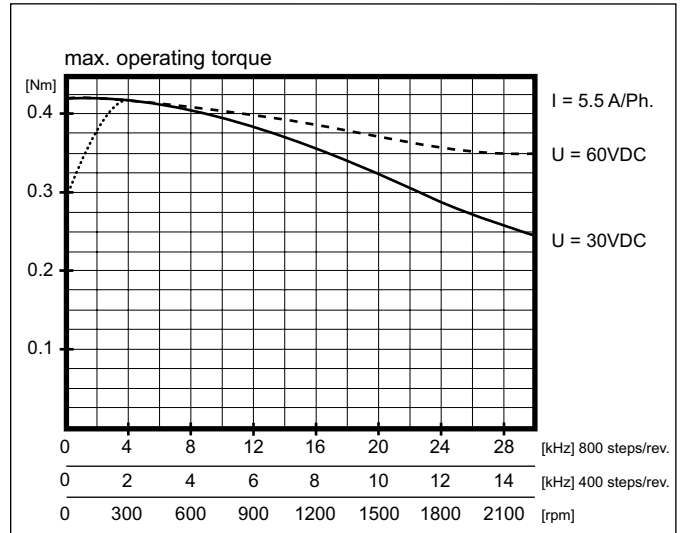

**SM 56.2.18J2**

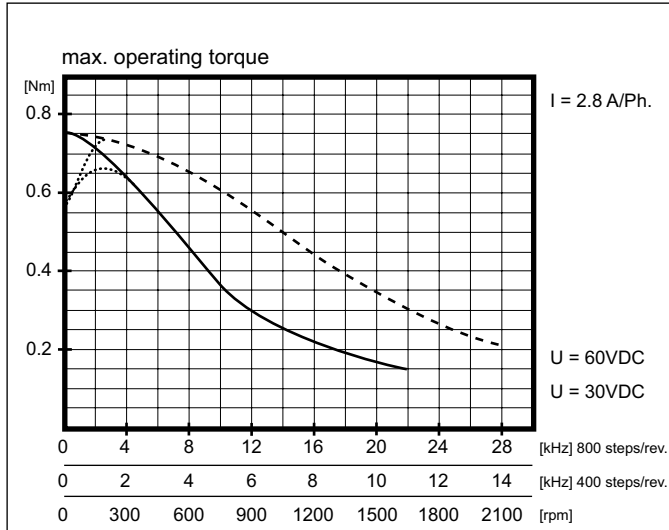

**SM 56.2.18J3**

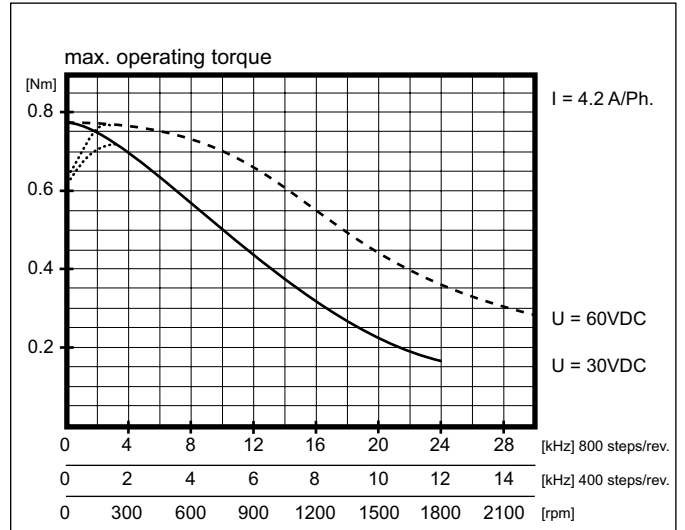

**SM 56.3.18J3**

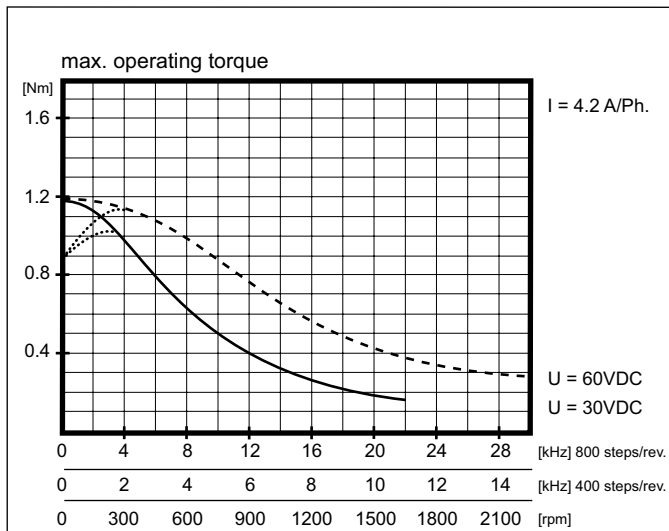

**SM 56.3.18J4.6**

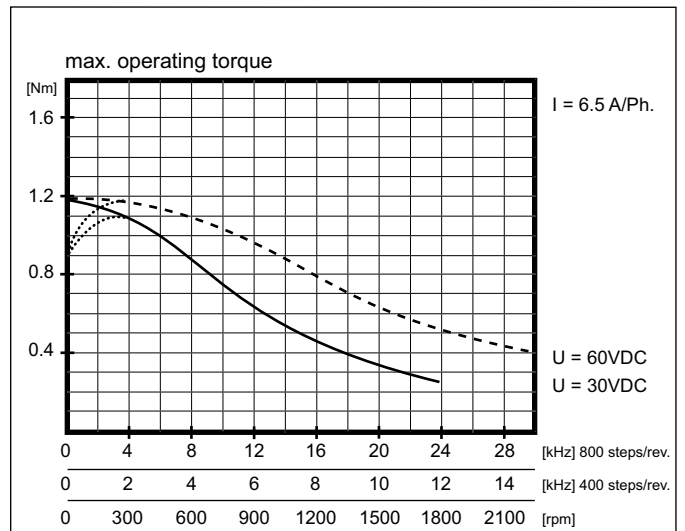

# 10 max. operating torque series SM 87



SM 168    SM 107    **SM 87/88**    SM 56

All printed torque performance curves are measured with **STÖGRA drives**.

- measured with 60 VDC
- - - - - measured with 120 VDC
- ..... without boost

## SM 87.1.18M1.6

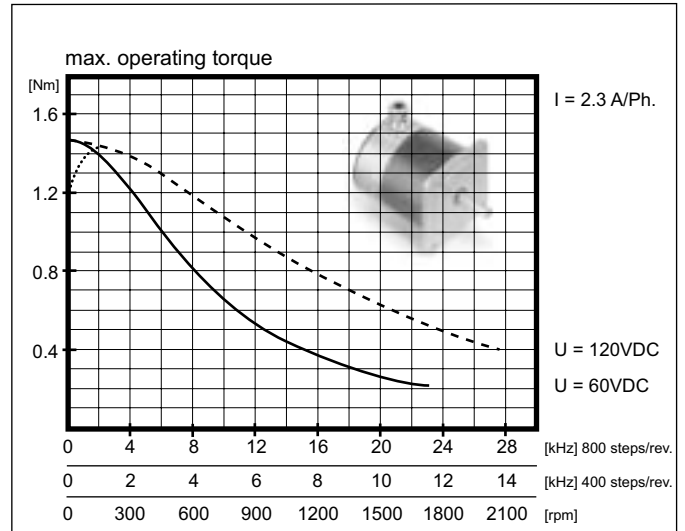

## SM 87.2.18M3.5

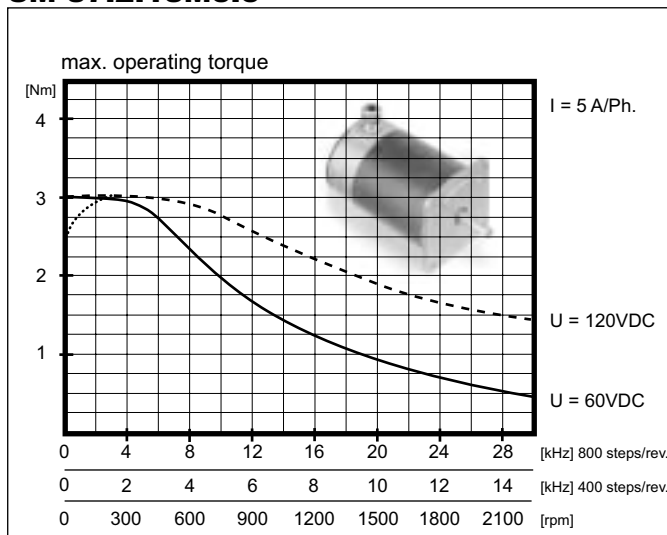

## SM 87.2.18M4.6

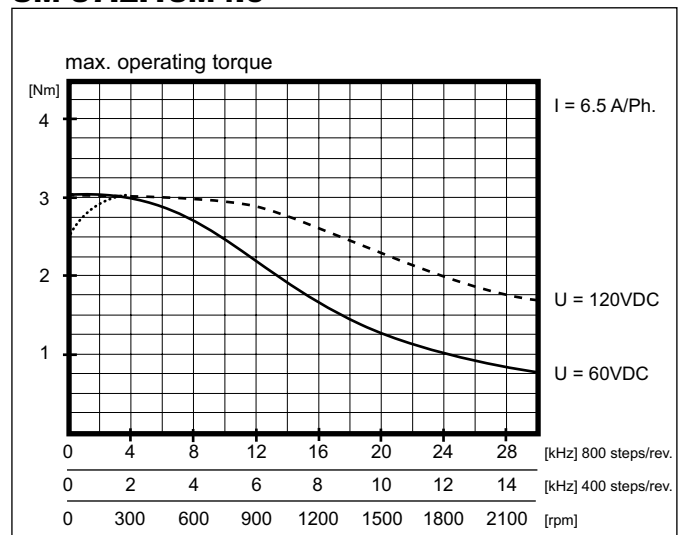

## SM 87.3.18M3.5

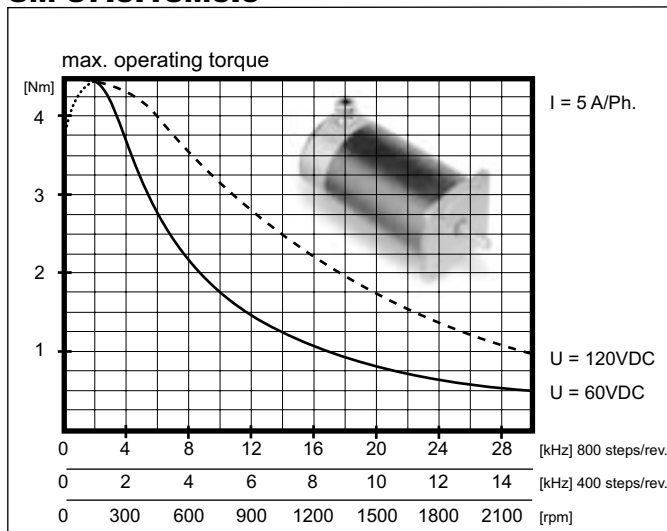

## SM 87.3.18M6

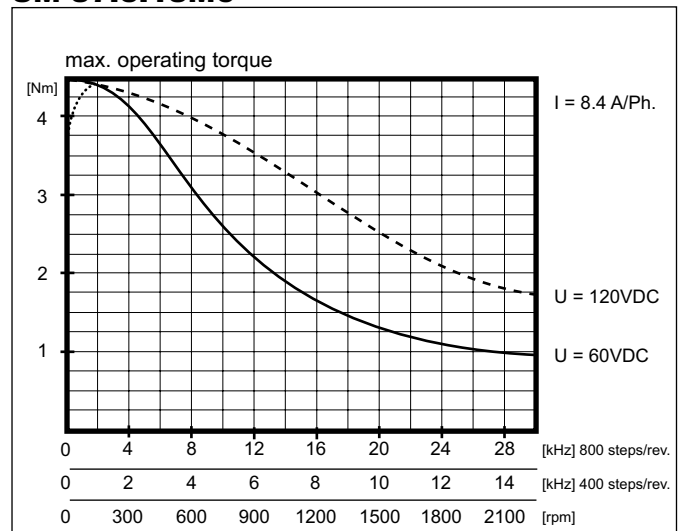

**SM 87.1.18M3**

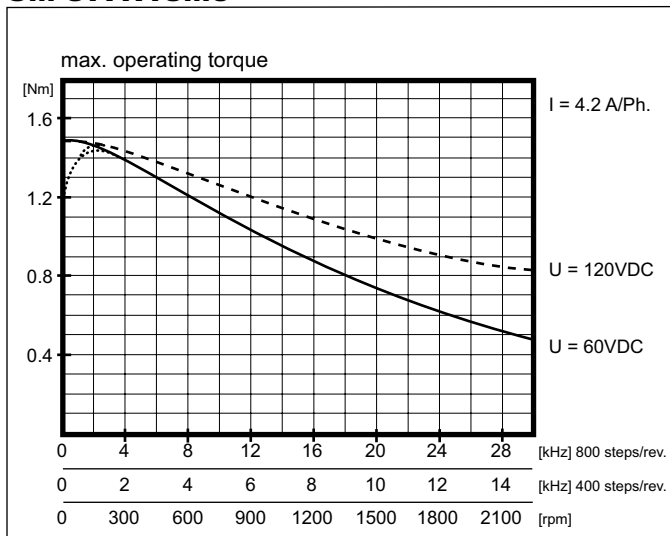

**SM 87.1.18M5**

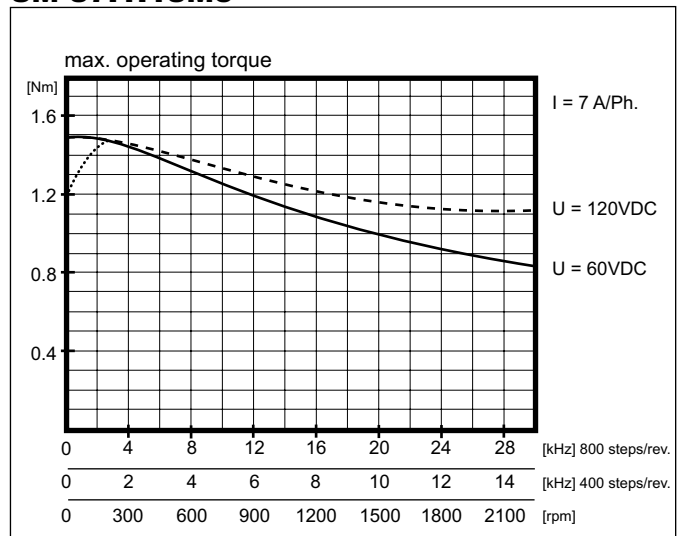

**SM 87.2.18M6**

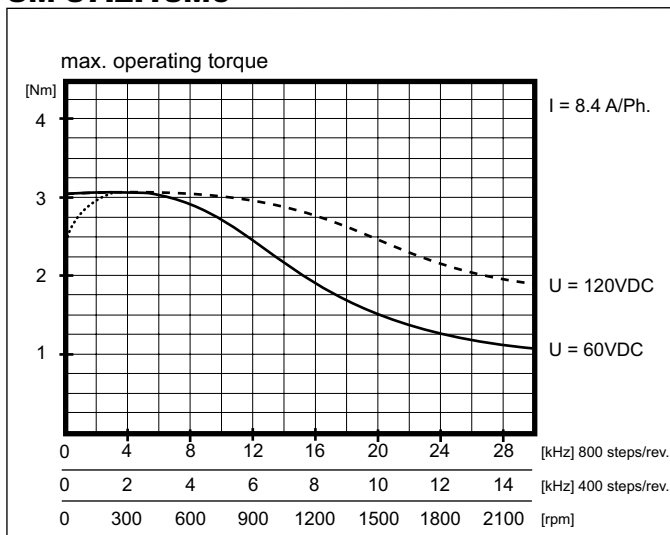

**SM 87.4.18M6**

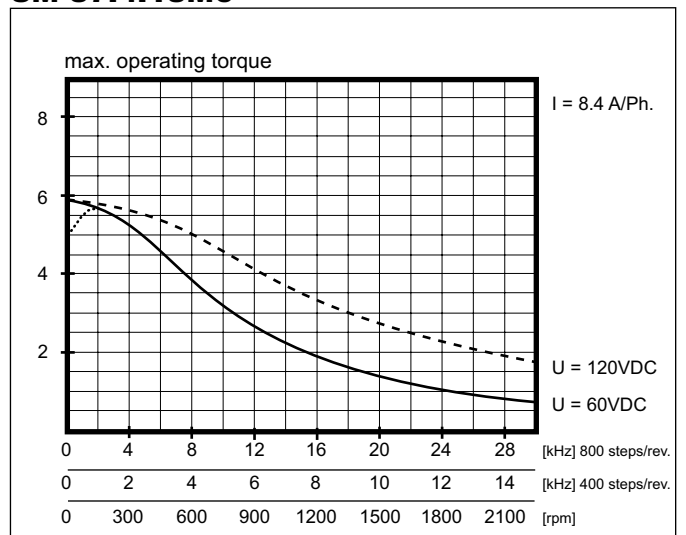

**SM 87.3.18M7**

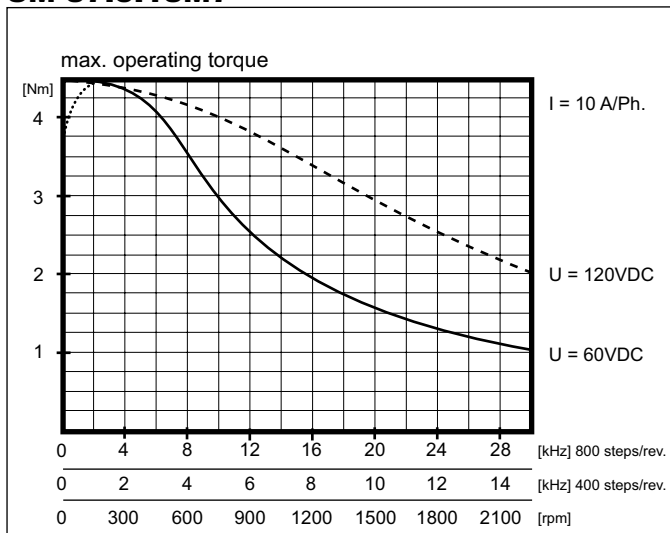

**SM 87.4.18M7**

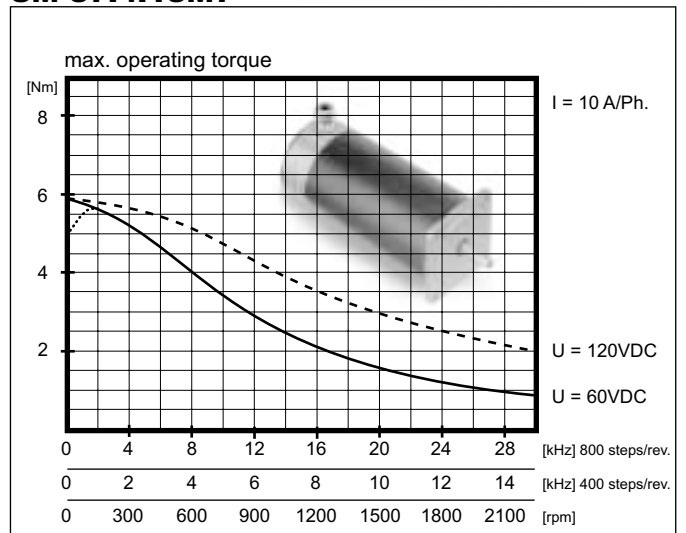

# 12 max. operating torque series SM 88



SM 168    SM 107    **SM 87/88**    SM 56

All printed torque performance curves are measured with **STÖGRA drives**.

- rectangular current characteristics
- rectangular current characteristics
- sinus current characteristics

## SM 88.1.18M2

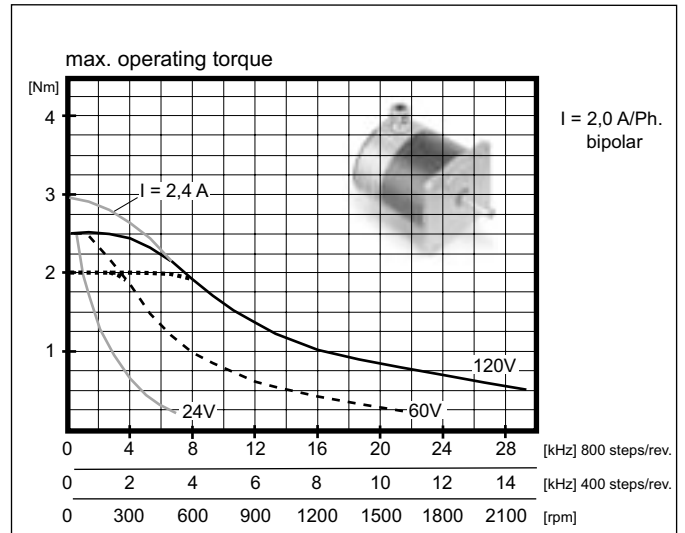

## SM 88.2.18M2

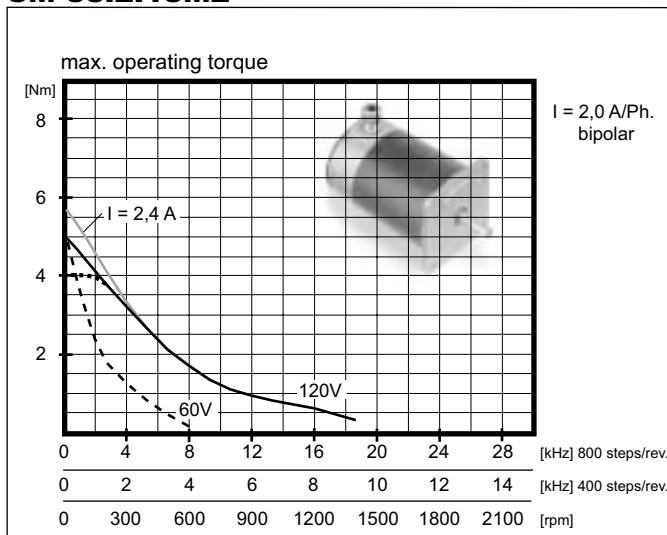

## SM 88.2.18M4

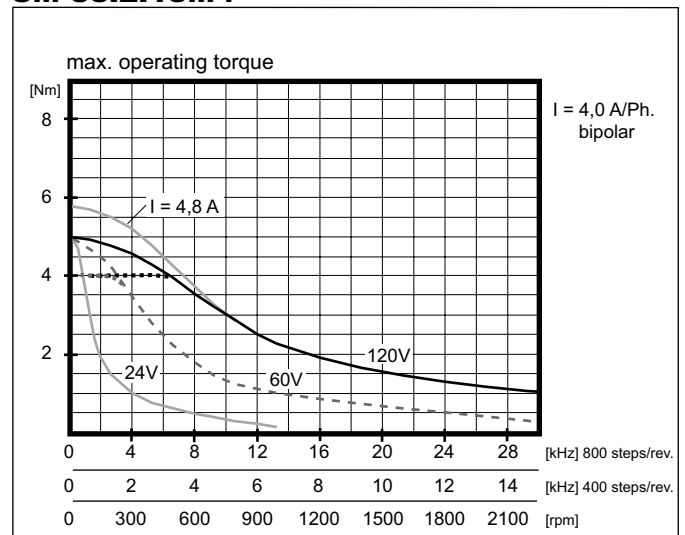

## SM 88.3.18M4

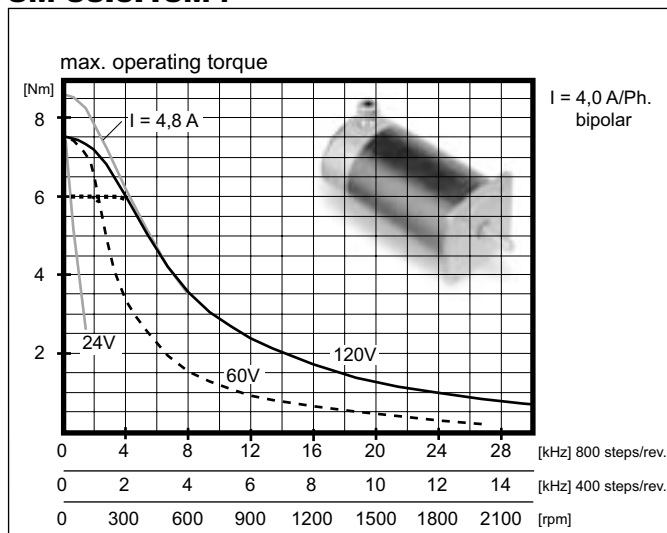

## SM 88.3.18M8

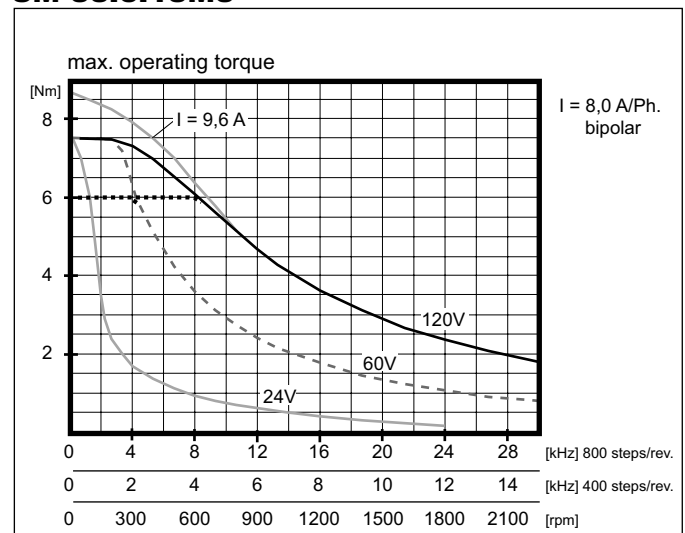

**SM 88.1.18M4**

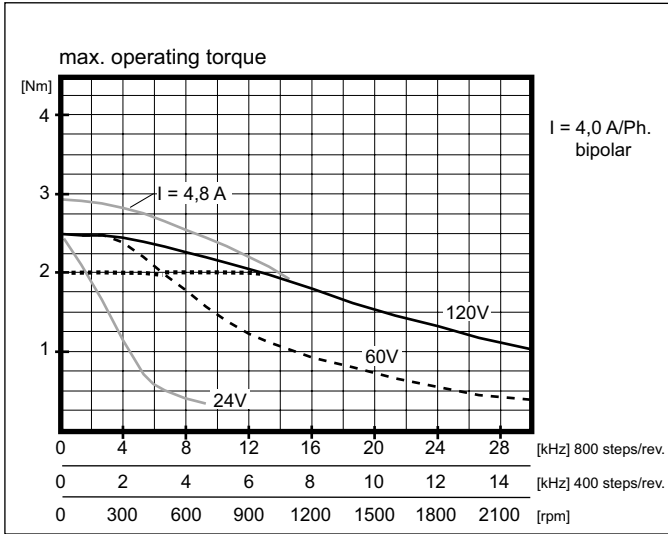

**SM 88.1.18M8**

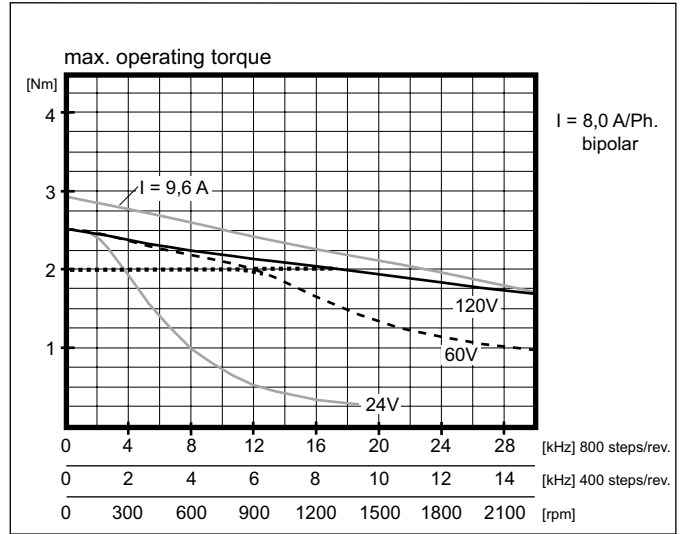

**SM 88.2.18M8**

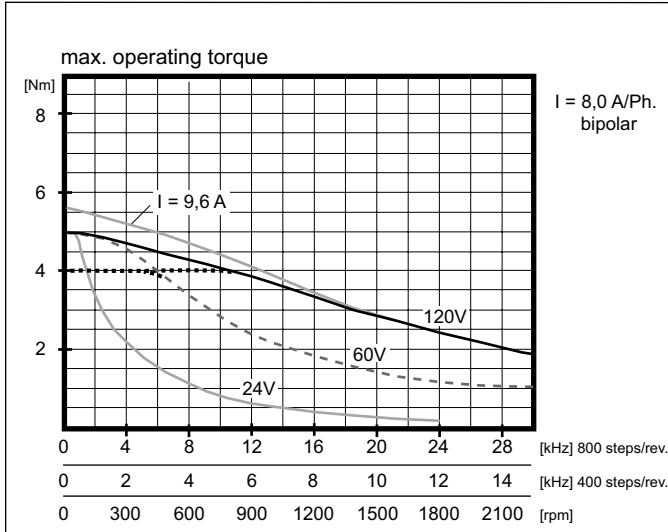

**SM 88.4.18M8**

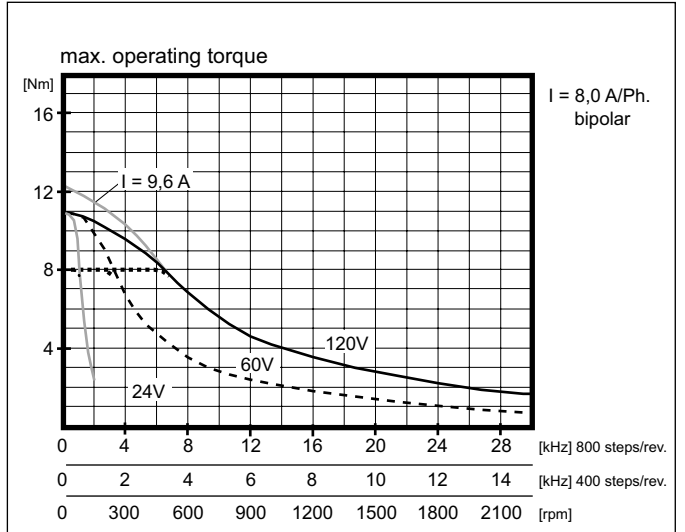

**SM 88.3.18M12**

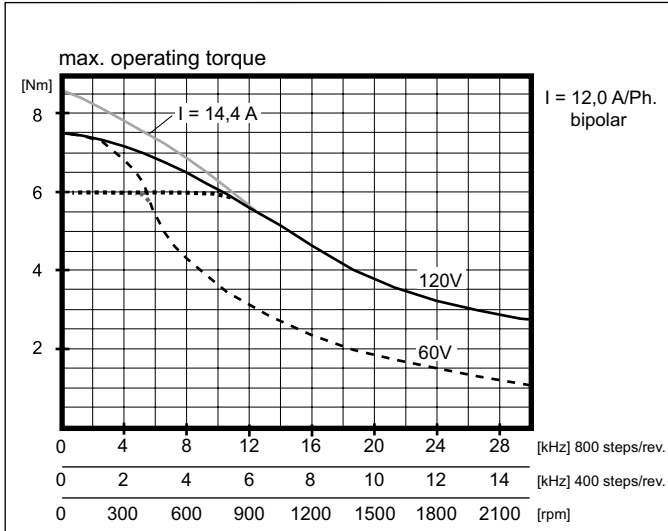

**SM 88.4.18M12**

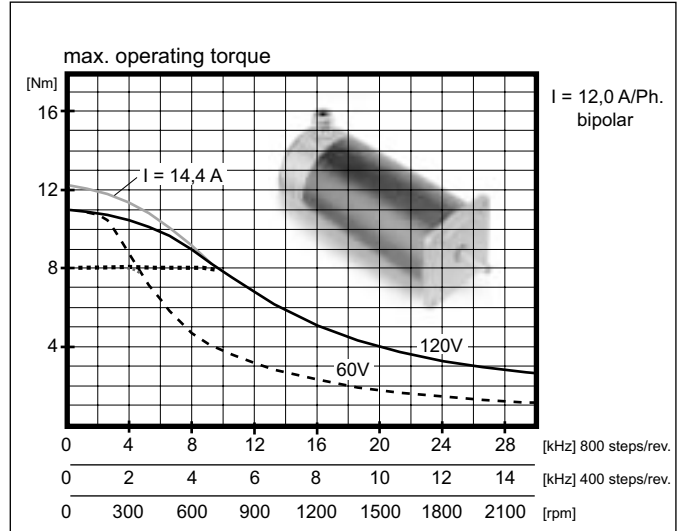

# 14 max. operating torque series SM 107



SM 168      **SM 107**      SM 87/88      SM 56

All printed torque performance curves are measured with **STÖGRA drives**.

- measured with 60 VDC
- - - - - measured with 120 VDC
- ..... without boost

## SM 107.1.18M6

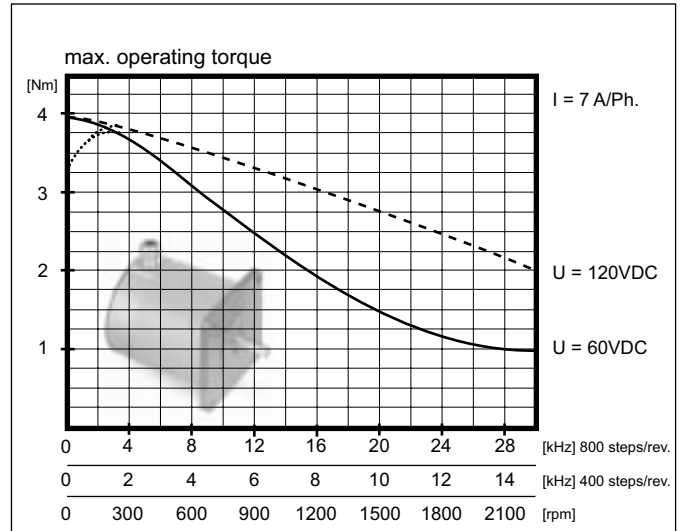

## SM 107.2.18M8

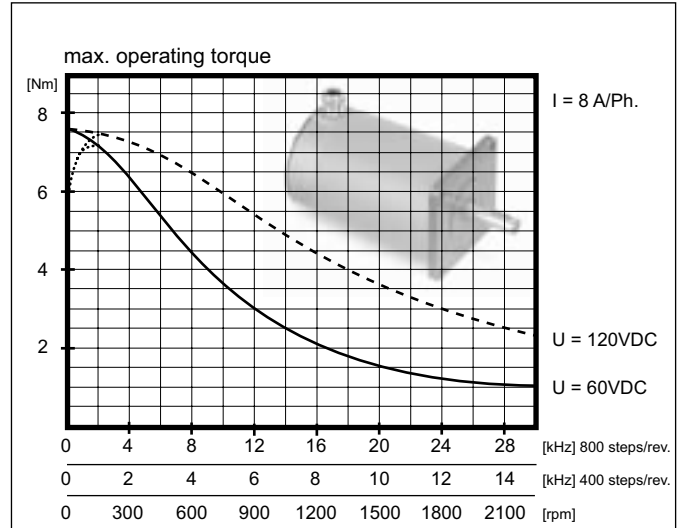

## SM 107.3.18M10

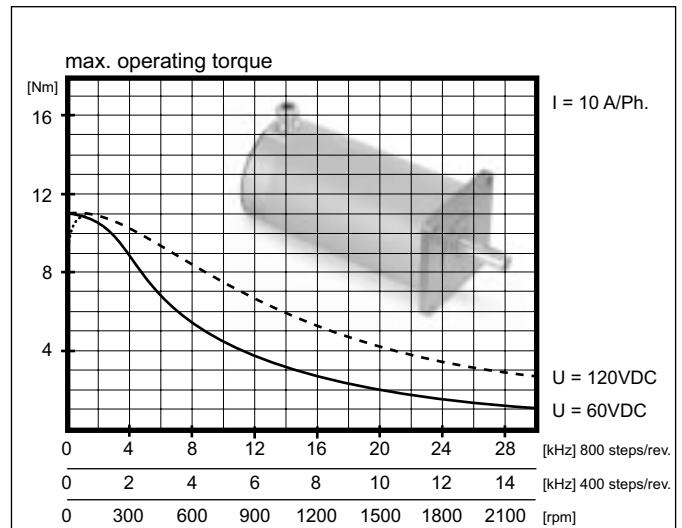

**SM 107.1.18**

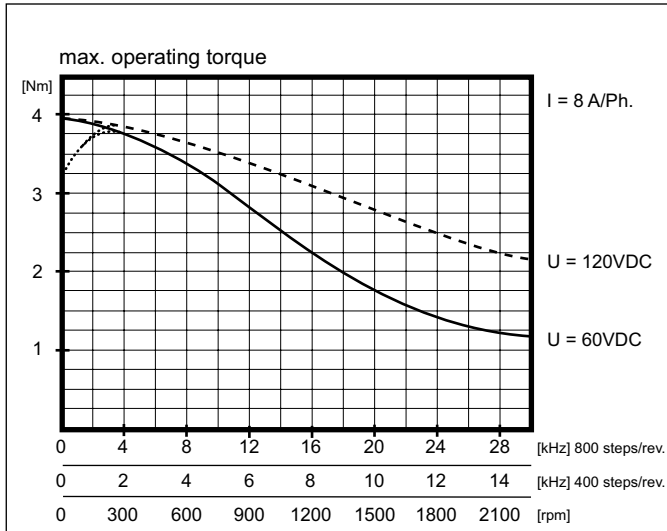

**SM 107.1.18M12**

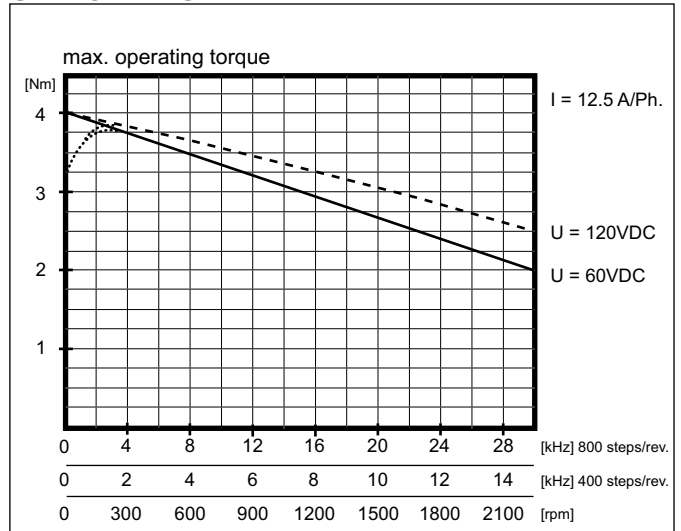

**SM 107.2.18M10**

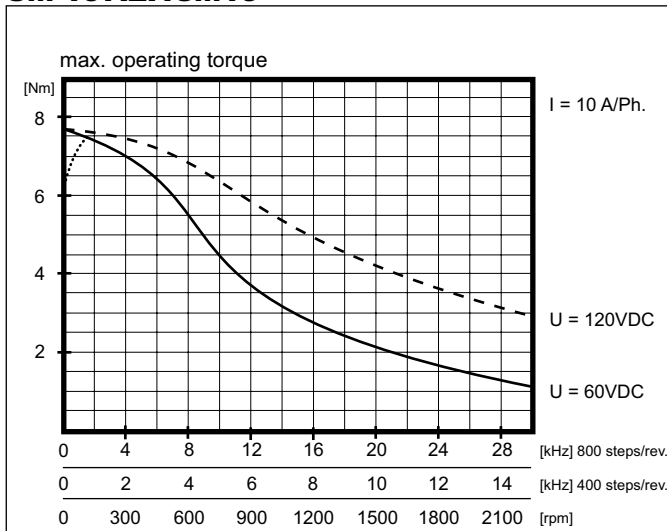

**SM 107.2.18M12**

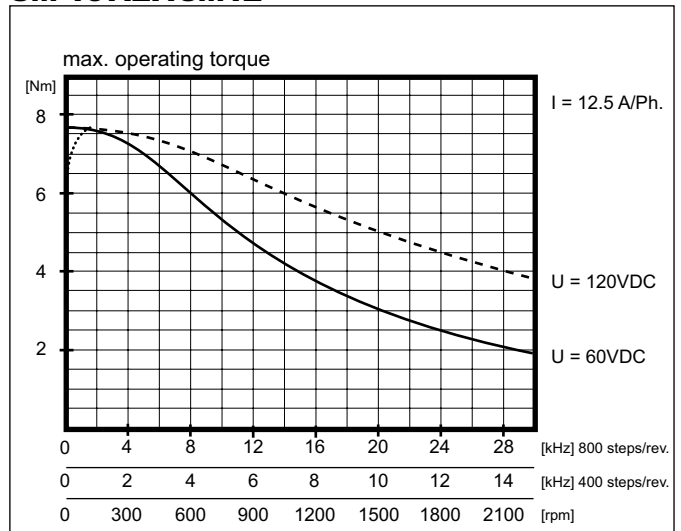

**SM 107.3.18M12**

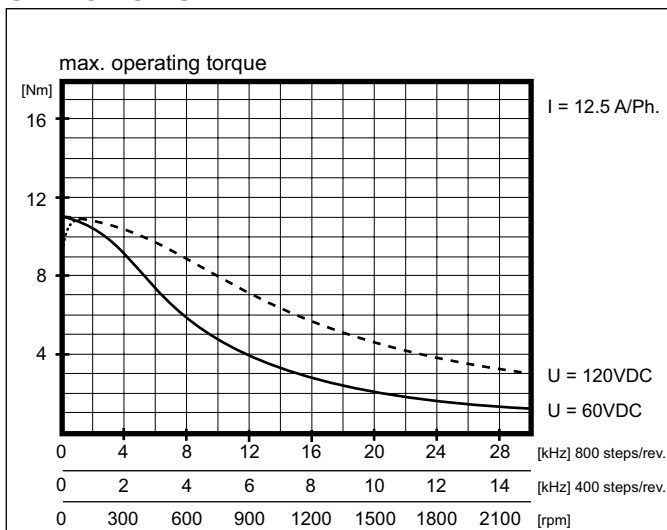

**SM 107.4.18M12**

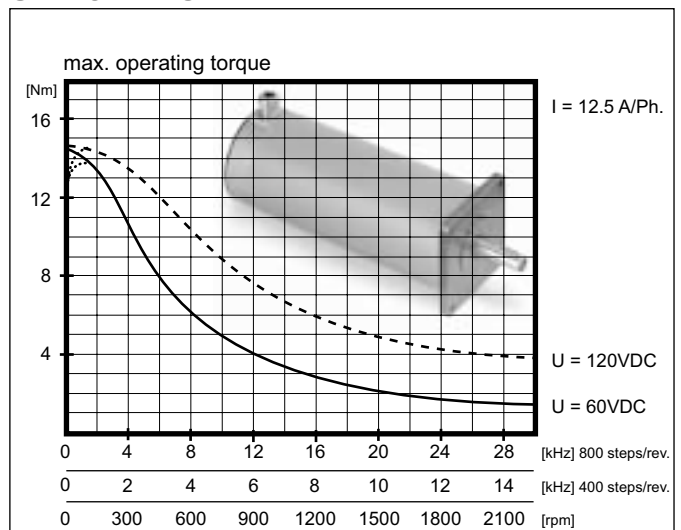

# 16 max. operating torque series SM 87 with WSE xx.230AC

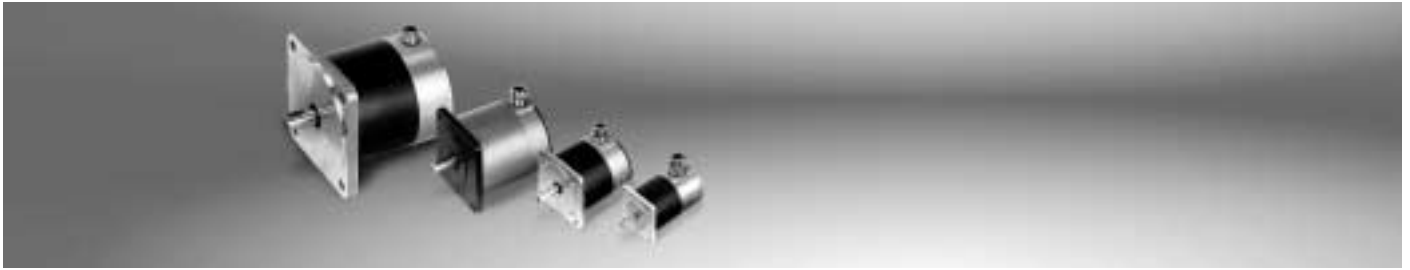

SM 168    SM 107    **SM 87/88**    SM 56

All printed torque performance curves are measured with **STÖGRA drives** type WSE xx.230AC (320VDC).

- rectangular current characteristics
- - - - - rectangular current characteristics with 20% boost
- ..... sinus current characteristics

**SM 88.1.18M2 with WSE 04.230AC**

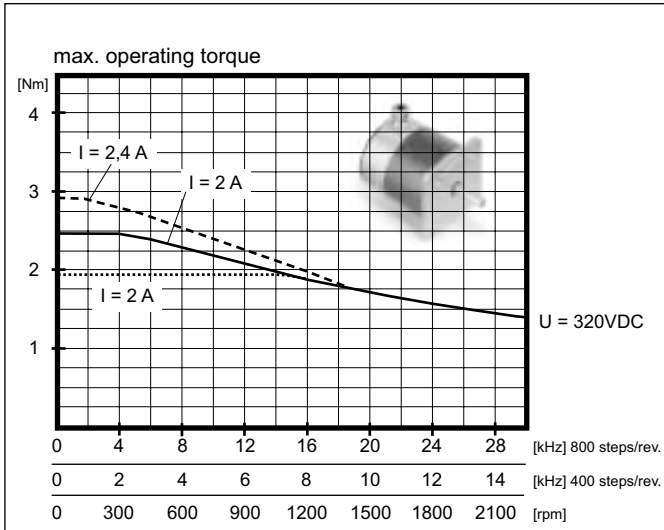

**SM 88.2.18M2 with WSE 04.230AC**

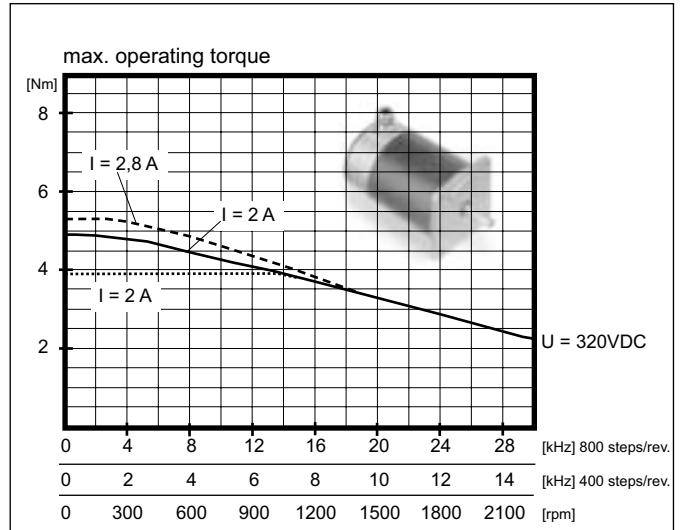

**SM 88.3.18M4 with WSE 04.230AC**

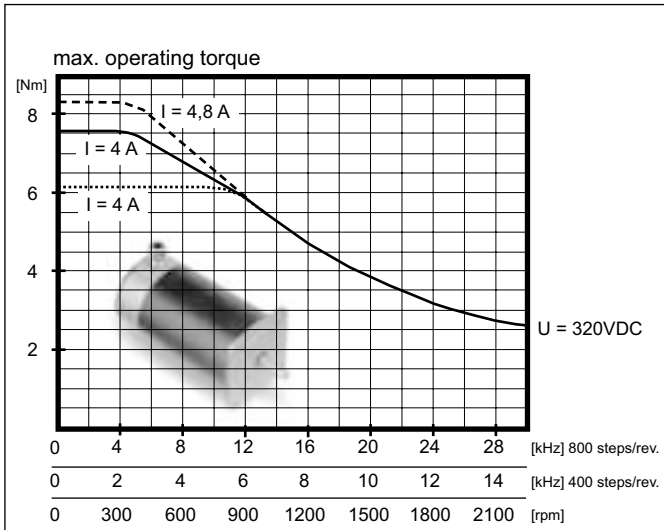

**SM 88.4.18M4 with WSE 04.230AC**

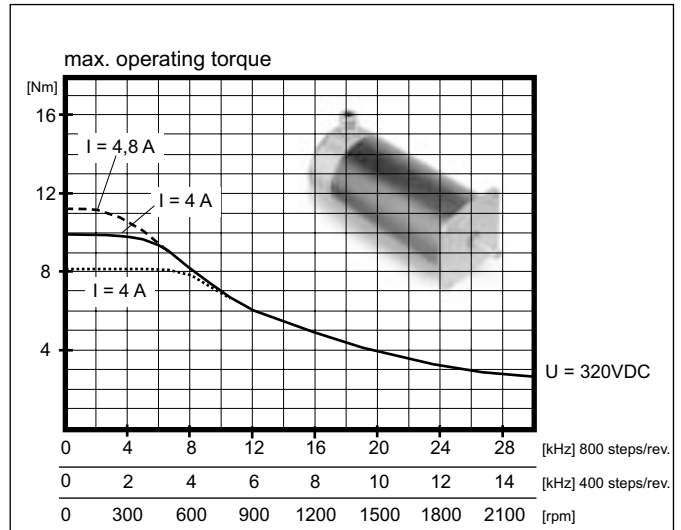





SM 168 SM 107 **SM 87/88** SM 56

All printed torque performance curves are measured with **STÖGRA drives** type WSE xx.230AC (320VDC).

- rectangular current characteristics
- - - - - rectangular current characteristics with 20% boost
- ..... sinus current characteristics

**SM 88.1.18M2 with WSE 04.230AC**

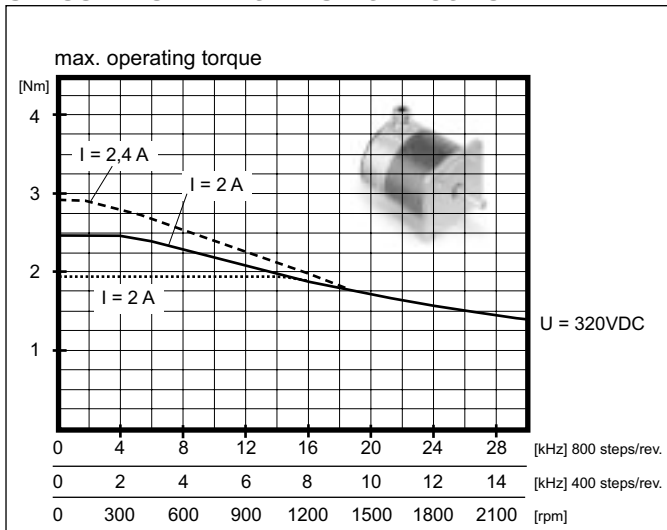

**SM 88.2.18M2 with WSE 04.230AC**

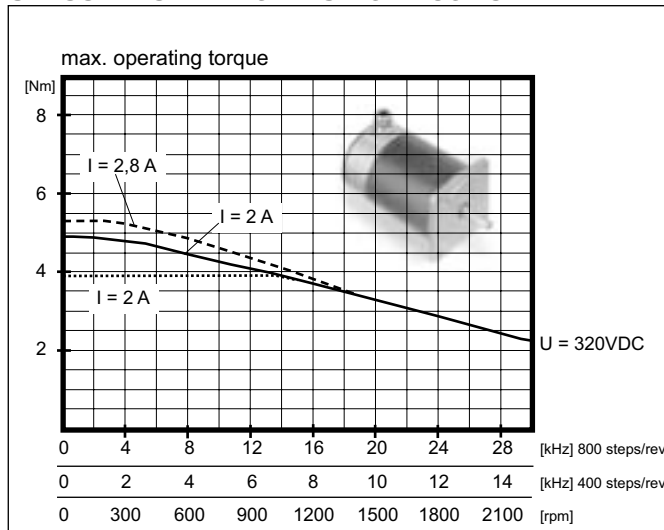

**SM 88.3.18M4 with WSE 04.230AC**

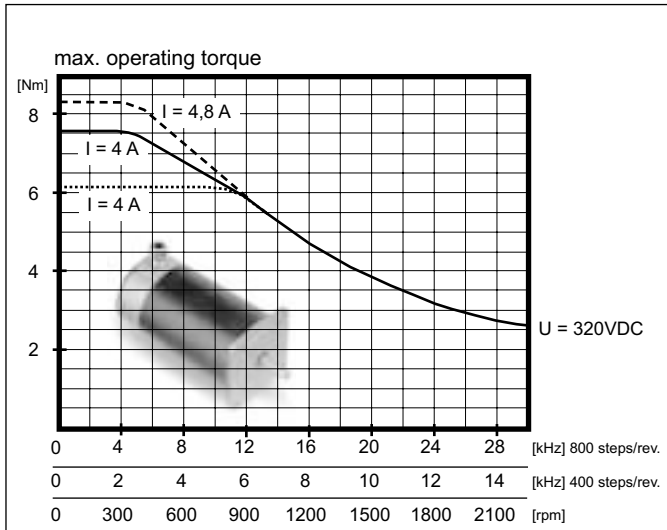

**SM 88.4.18M4 with WSE 04.230AC**

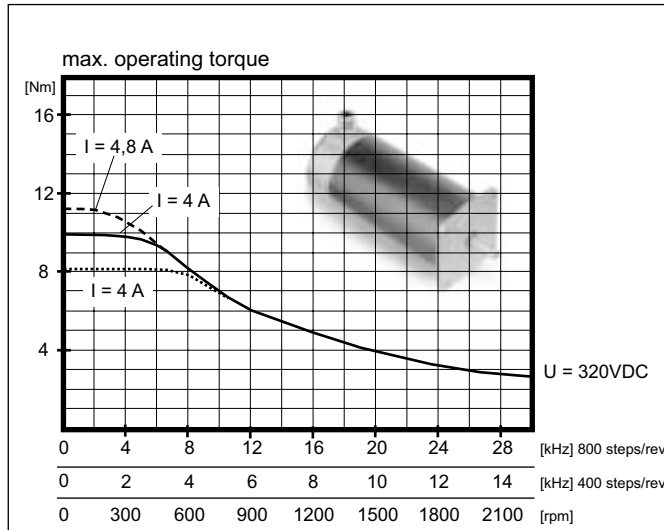

# 18 max. operating torque series SM 107 with WSE xx.230AC

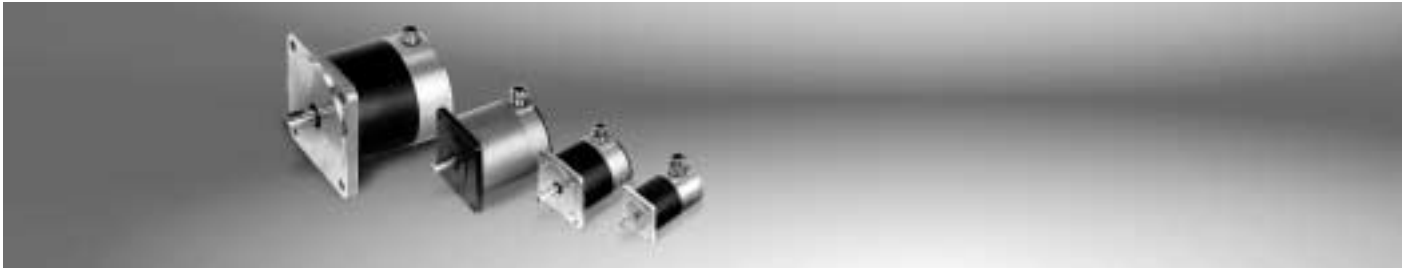

SM 168    **SM 107**    SM 87/88    SM 56

All printed torque performance curves are measured with **STÖGRA drives** type WSE xx.230AC (320VDC).

- rectangular current characteristics
- rectangular current characteristics with 20% boost
- ..... sinus current characteristics

## SM 107.1.18M4 with WSE 04.230AC

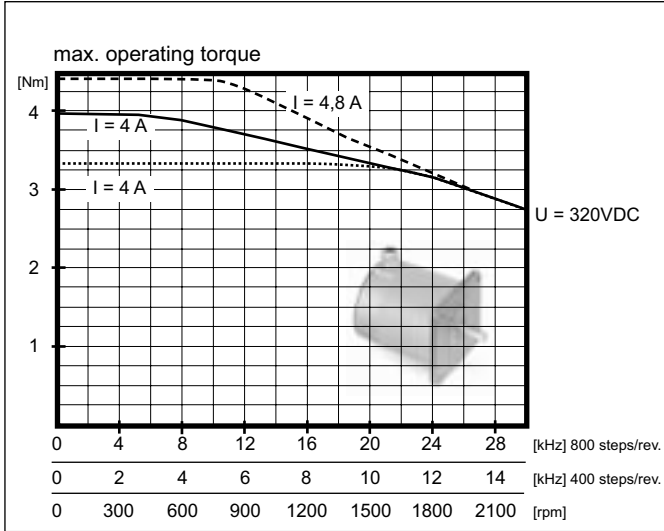

## SM 107.2.18M4 with WSE 04.230AC

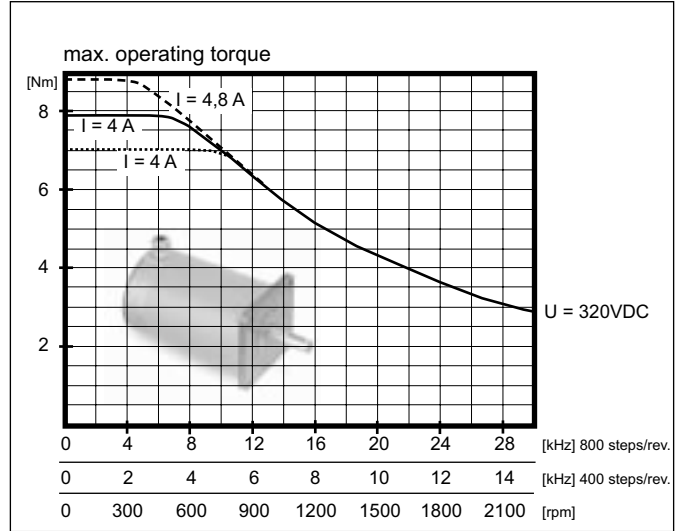

## SM 107.3.18M6 with WSE 06.230AC

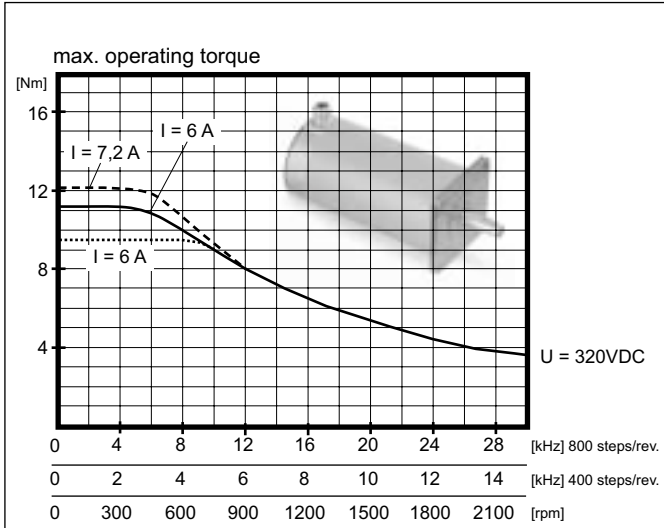

## SM 107.4.18M6 with WSE 06.230AC

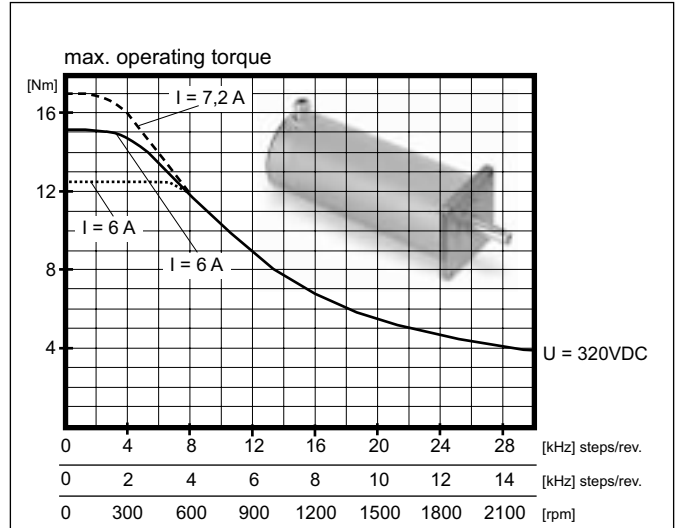



SM 168      SM 107      SM 87/88      **SM 56**

All printed torque performance curves are measured with **STÖGRA drives**.

- measured with 120 VDC
- - - - - measured with 240 VDC
- ..... without boost

**SM 168.1.18M12**

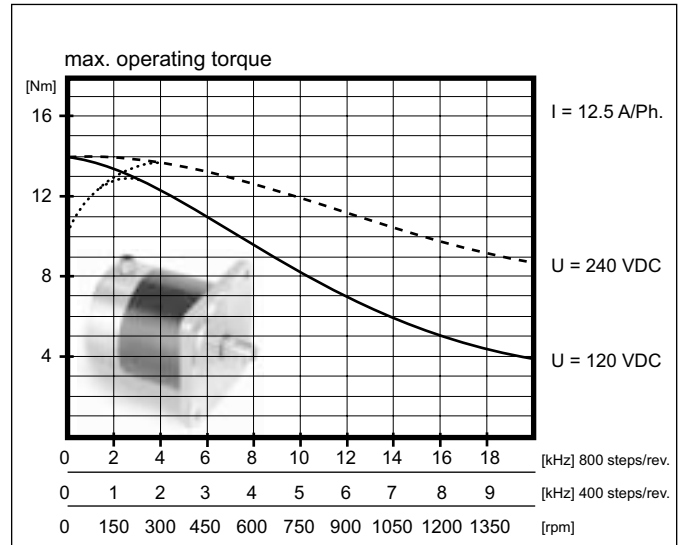

**SM 168.2.18M12**

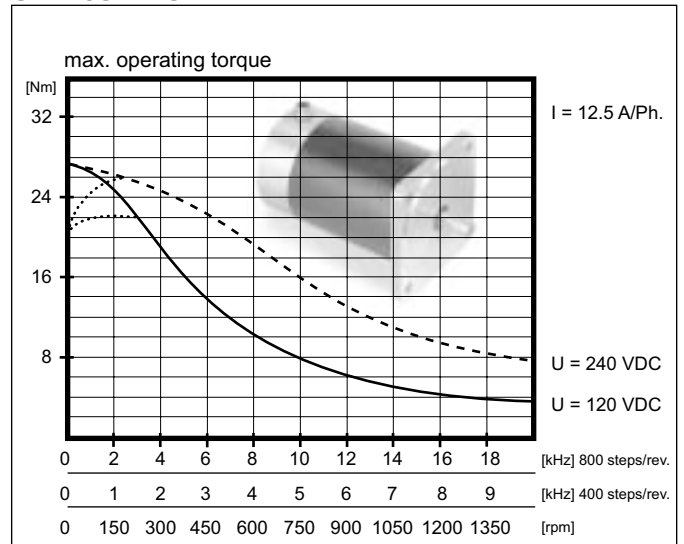

# 20 stepping motor phase current characteristics

----- rectangular characteristics – phase current  
 (fullstep / with boost)  
 both phases with nominal current (bipolar)

..... sinus-/cosinus characteristics – phase current  
 (without boost)  
 with peak value = nominal current (bipolar)

e.g. SM 88.2.18M8  
 with nominal current 8 A/phase bipolar

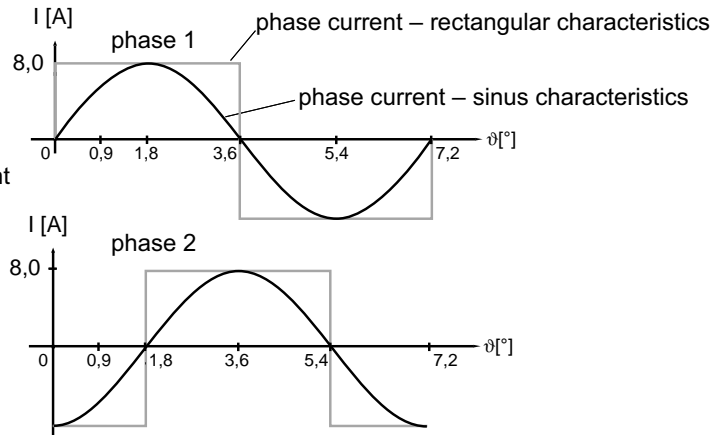

**series SMH 88**

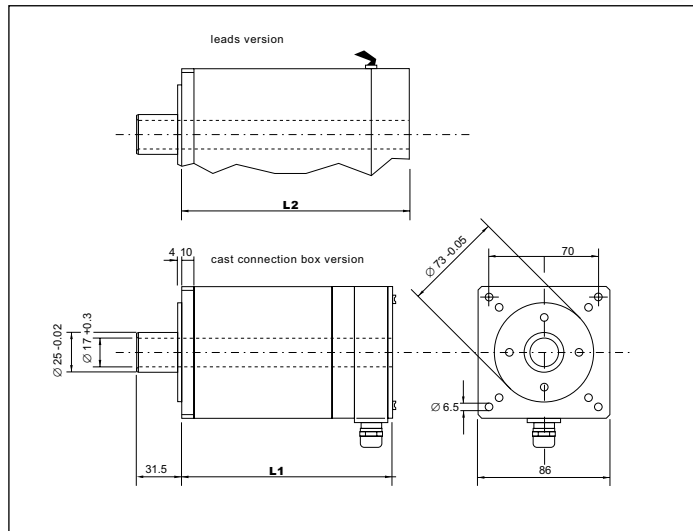

series	type	L1 [mm]	L2 [mm]
<b>SMH 88</b>	SMH 88.1.18M ...	112.5	87
	SMH 88.2.18M ...	144.5	119
	SMH 88.3.18M ...	176.5	151
	SMH 88.4.18M ...	208.5	183

all dimensions in mm

**series SMH 107**

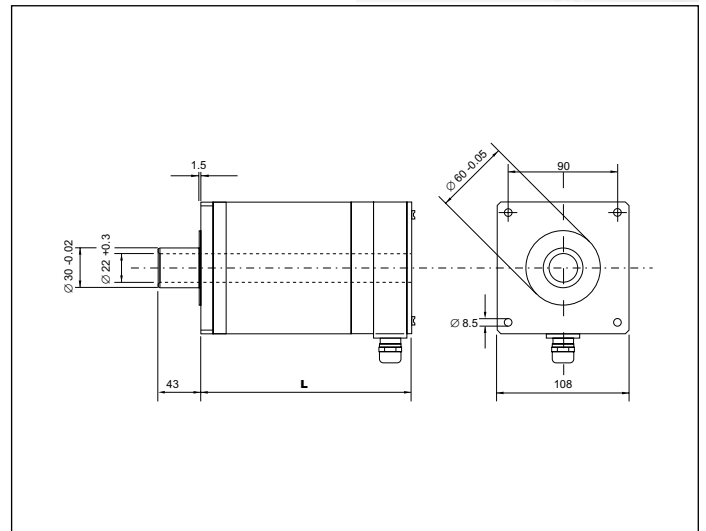
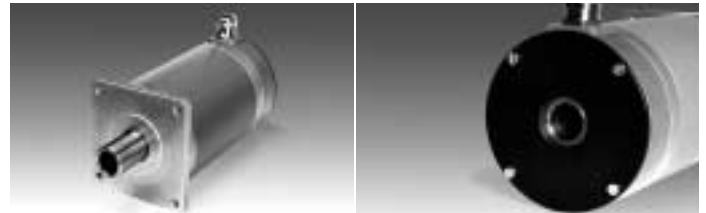

series	type	L±1
<b>SMH 107</b>	SMH 107.1.18M ...	140
	SMH 107.2.18M ...	190
	SMH 107.3.18M ...	240
	SMH 107.4.18M ...	290

all dimensions in mm

**Type key**

**SMH  .  . 18M**

<b>type</b>	<b>88</b>	<b>107</b>						
<b>length (quantity of stacks)</b>	<b>1</b>							
	<b>2</b>							
	<b>3</b>							
	<b>4</b>							
<b>connection</b>								
leads	<b>L</b>							
connector angled	<b>X</b>							
connector straight	<b>Y</b>							
cast connection box (without indication)								
		<b>Options</b>						
		<b>W</b>	double shaft end					
		<b>Z x</b>	customer specific version (No. x will be specified by STÖGRA)					
		<b>phase current in A/Ph</b>						
		<b>2</b>	depending on motor type					
		<b>12</b>	– see electrical specifications					

examples for ordering key: **SMH 88.2.18ML4**  
**SMH 107.3.18M12**

Electrical and mechanical specifications and max. operating torques for series SMH 88 are identical to series SM 88 (see page 7 and pages 12 to 13). For series SMH 107 the specifications are identical to series SM 107.

# 22 stepper motor connections

## standard stepping motors connection series SM 87, SM 88 und SM 107

<p>windings <b>bipolar parallel</b></p> <p><b>SM 87/107/168.....</b></p>	<p>windings <b>bipolar serial</b></p> <p><b>SM 87/107/168.....</b></p>	<p>colour assignment of leads version <b>SM 56/87/107...L..</b></p> <p>phase 1</p> <ul style="list-style-type: none"> <li>1 = brown</li> <li>2 = white</li> <li>3 = black</li> <li>4 = red</li> </ul> <p>phase 2</p> <ul style="list-style-type: none"> <li>5 = blue</li> <li>6 = grey</li> <li>7 = yellow</li> <li>8 = green</li> </ul> <p>PE = yellow-green</p>
<p>windings <b>bipolar parallel</b></p> <p><b>SM 88.....</b></p>	<p>windings <b>unipolar</b></p> <p><b>SM 87/107/168.....</b></p>	<p>colour assignment of leads version <b>SM 88...L..</b></p> <p>phase 1</p> <ul style="list-style-type: none"> <li>1 / 2 = brown</li> <li>3 / 4 = black</li> </ul> <p>phase 2</p> <ul style="list-style-type: none"> <li>5 / 6 = blue</li> <li>7 / 8 = yellow</li> </ul> <p>PE = yellow-green</p>

## connections stepper motors series SM 87, SM 88 and SM 107 with brake and encoder E50

<p><b>SM 87/88/107 ...B</b> Stepper motor with brake</p>	<p><b>SM 87/88/107 ...E50</b> Stepper motor with encoder E50</p>	<p><b>SM 87/88/107 ...BE50</b> Stepper motor with encoder E50 and brake</p>

The windings of types SM ...B, SM ...E50 and SM ...B E50 are for bipolar connection only (connections correspond to bipolar parallel).

**Connections stepper motors series SM 56 standard, and connections motors series SM 56 with options brake and encoder E50**

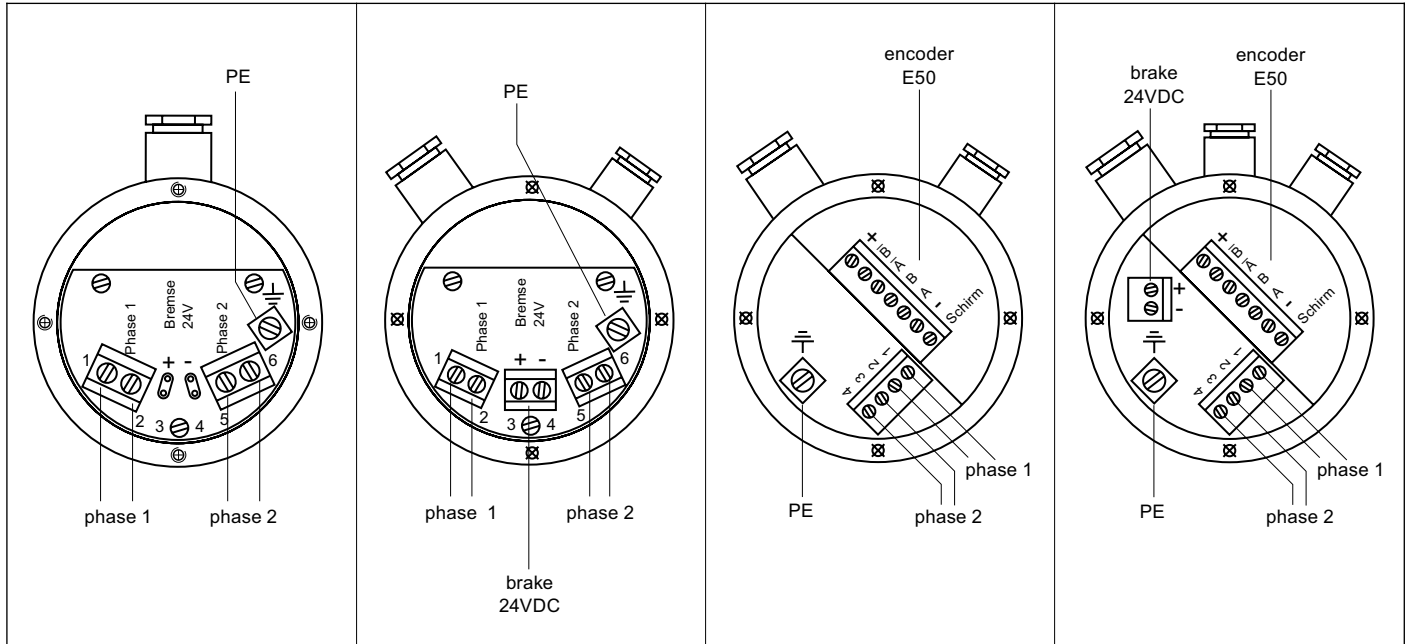

**SM 56 ...**  
Stepper motor with terminal box

**SM 56 ...B**  
Stepper motor with brake

**SM 56 ...E50**  
Stepper motor with encoder E50

**SM 56 ...B E50**  
Stepper motor with encoder E50 and brake

The windings of types SM ...B, SM ...E50 and SM ...B E50 are for bipolar connections only (connections correspond to bipolar parallel). Leads connections of motors SM 56...L... are identical to the connections of the leads version of motors SM 87 / SM 107 at page 20.

**Connections stepper motors series SM 56, SM 87, SM 88 and SM 107 with brake and encoder H200/H500**

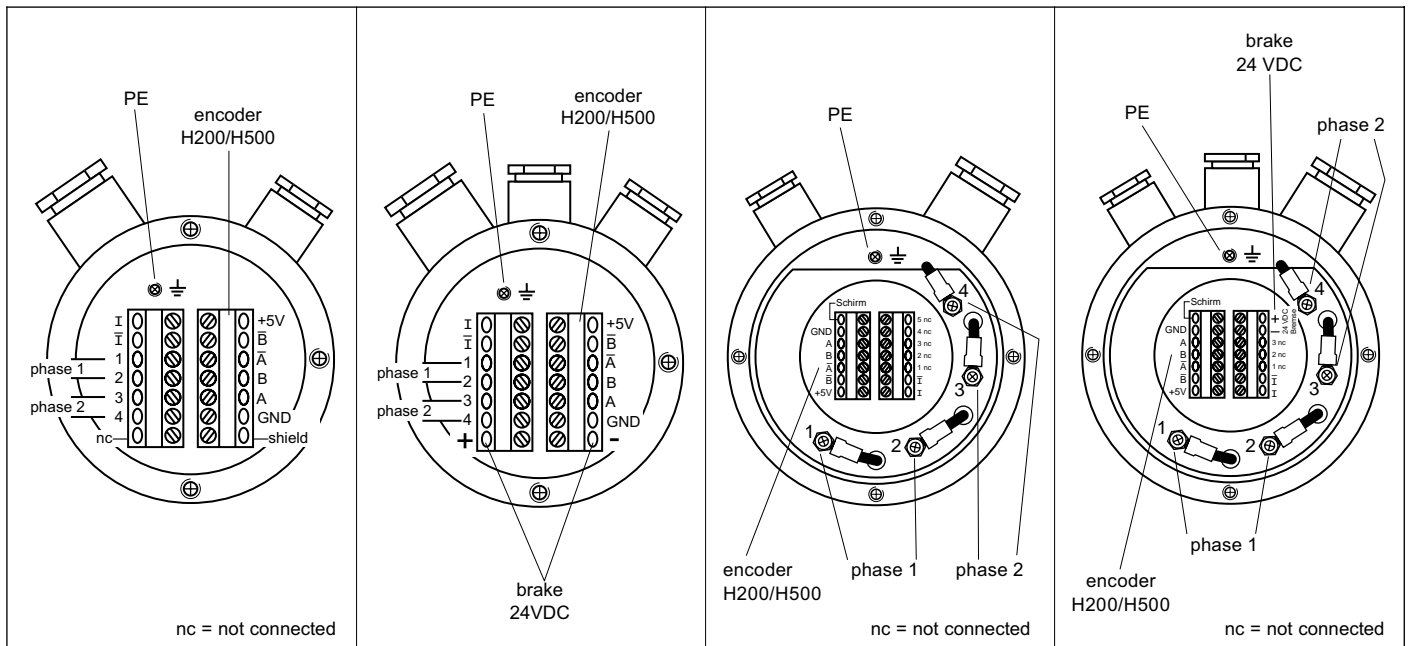

**SM 56 ...H200/H500**  
Stepper motor with encoder H200 / H500

**SM 56 ...B H200/H500**  
Stepper motor with encoder H200 / H500 and brake

**SM 87/88/107 ...H200/H500**  
Stepper motor with encoder H200 / H500

**SM 87/88/107 ...B H200/H500**  
Stepper motor with encoder H200 / H500 and brake

## 24 stepper motors versions with connectors

### Stepper motors with connections via circular connectors series SM ...X and SM ...Y

STÖGRA motors SM 56, SM 87, SM 88 and SM 107 are available optionally with connections via robust industry conform circular connectors type M23.

The standard options »encoder« and »brake« are available for both connector versions.

Available are standard versions with **angled** connectors series SM ...X... and with **straight** connectors series SM ...Y... (the connector for the brake connection ist always straight).



SM 56.3.18JX4,6B E50 with angled connectors series SM ...X...

SM 56.2.18JY3 with straight connector series SM ...Y...

SM 87.2.18MX6 with angled connector series SM ...X...

SM 87.2.18MY6 E50 with straight connectors series SM ...Y...

All connectors mounted at the motor include male contacts. The necessary counter connectors include female contacts.

Connector housings for the connections motor phases and encoder are metallic (zinc diecasting with nickled surface). Protection class of the connectors is IP67. The counter connectors are EMC-justed and a cable shield may be mounted. The connector for the brake is made of PVC, protection class also is IP67.

Ordering examples (see also ordering key at page 4):

SM 56.2.18JX3 E50 (with angled connectors and encoder E50)

SM 87.2.18MX6B (with angled connectors and brake)

SM 87.1.18MY3 H200 (with straight connectors and encoder H200)

The counter connectors are not included in the deliveries. Counter connectors have to be ordered seperately.

ordering no.	connector angled	connector straight	motor-phases	encoder E50 / H200 / H500	brake	crimp-connection	soldering-connection	cable Ø mm
GS X	X		X			X		7 – 12 mm
GS XL	X		X				X	7 – 12 mm
GS Y		X	X			X		7 – 12 mm
GS YL		X	X				X	7 – 12 mm
GS X E	X			X		X		5 – 10 mm
GS XL E	X			X			X	5 – 10 mm
GS Y E		X		X		X		5 – 10 mm
GS YL E		X		X			X	5 – 10 mm
GS X B	X				X		X	5 – 10 mm

The counter connectors for connections motor phases and encoder each include a mounting set with connector housing, connectors pin socket and connector pins (female pins).



**Stepper motors with connections via circular connectors series SM ...X and SM ...Y**

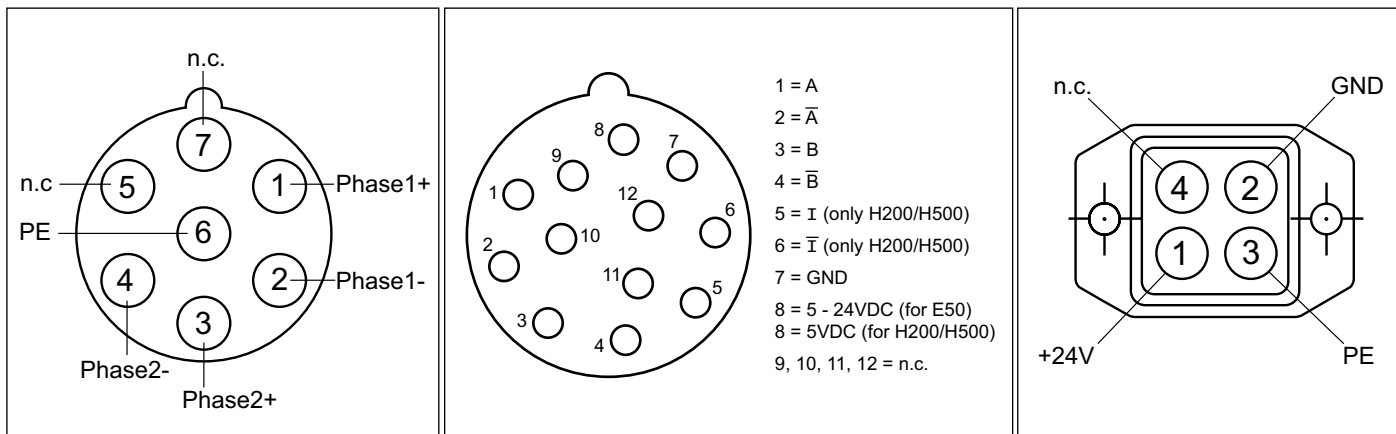

connector motor phases

connector encoder

connector brake

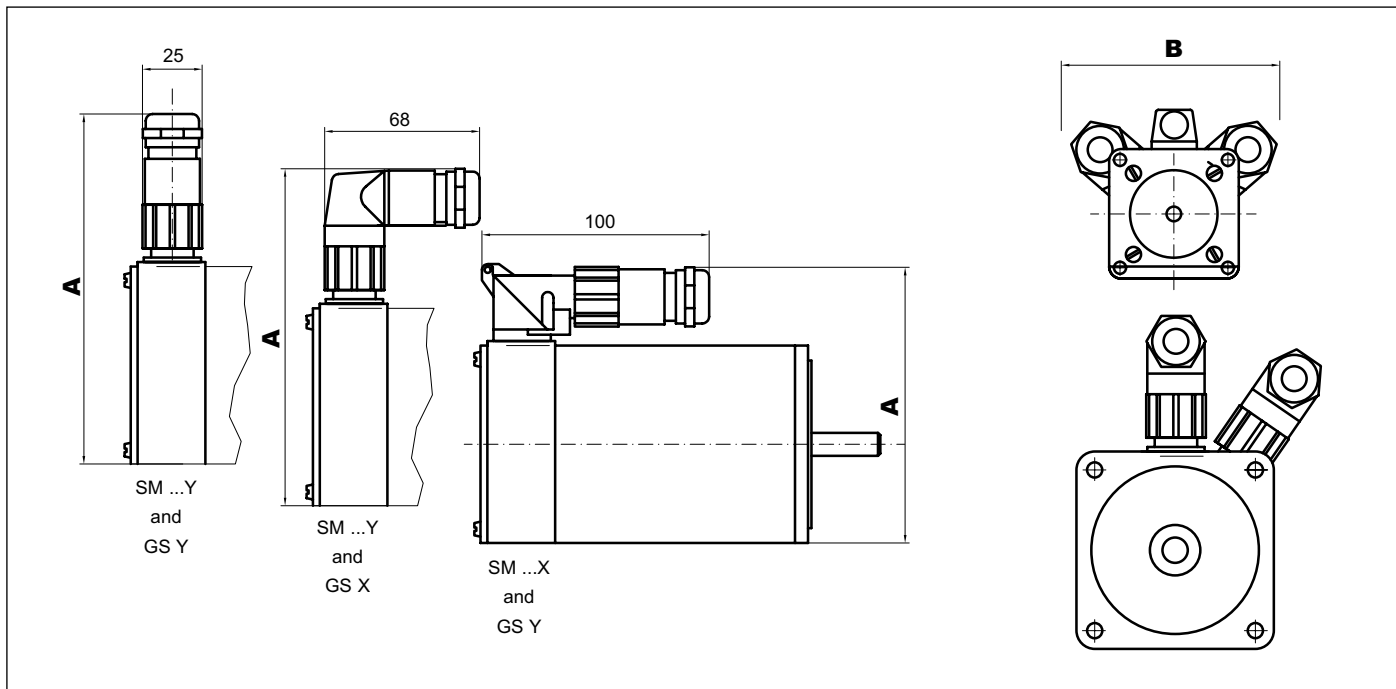

dimensions A			
	SM...Y and counter connector straight	SM...Y and counter connector angled	SM...X and counter connector straight
SM 56	119	112	90
SM 87	152	145	123
SM 88	152	145	123
SM 107	176	167	145

Dimension A includes the dimensions connector and counter connector, but not connected cable.  
 Dimension B depends on motor type and the options (with / without brake, encoder).

## 26 stepper motor versions with connectors

### Stepper motors with connector according to Mil-C-5015 series SM ... Z257



STÖGRA stepper motors are available optionally with connectors according to the standard Mil-C-5015, which are widely used in the industry.

Connector mounted at the motor for connections motor phases (phases and PE):

MS3102R size 14s, 5 pole, male connector type (MS3102R14s-5P)

Suitable female connectors are e.g. types MS3101, MS3106, MS3108 each size 14s and 5 poles, female connector type

Example: MS3106R14s-5S

For option brake:

Mounted connector at the motor for an integrated brake: MS3102R size 10s, 2 poles, male connector type (MS3102R10s-4P).

Suitable female connectors are e.g. types MS3101, MS3106, MS3108 each size 10s und 2-poles, female connector type

Example: MS3106R10s-4S

The female counter connectors are not included in the delivery.

The motors need to be ordered with the type key extension »Z257«.

Ordering example: motor SM 88.2.18M8B Z257

### Stepper motors series SM 56 with 9-pole D-Sub connector



SM 56...Z154 with D-Sub connector

SM 56...E50 Z159 with D-Sub connector

SM 56... Z182 with D-Sub connector

For series SM 56 special versions with connections for motor, encoder and brake via 9-pole D-Sub connectors are available. There are three different versions available, which are shown in above pictures.

For all versions the options »brake« and »encoder E50« are possible.

For the version without encoder and without brake the motor includes a D-Sub-connector (male type) for the motor connections (phases + PE). Options »encoder E50« and »brake« additionally include one D-Sub-connector (female type) for each option.

All D-Sub connectors are standard 9-pole D-Sub connectors.

At the Z182-version the maximum bipolar phase current may not exceed 4,2A (SM 56.1.18J3,9 and SM 56.3.18J4,6 are not available with a D-Sub connector version Z182 - for possible special versions with special D-Sub connectors please contact us).

At motor stand still a phase current reduction to 50% of the running current should be activated in the motor control.

Ordering example: SM 56.1.18J3 Z154, SM 56.2.18J2B E50 Z159, SM 56.3.18J1,5 E50 Z182

### Stepper motors for extended operating temperature range – options Z80 and Z240

The operating temperature range for all STÖGRA standard motors is -30°C until 80°C permanently (short time 100°C). This max. allowed temperature at the motor surface (measured at stator housing - backside near the cast connection box) may not exceeded. The motor temperature reached during operation depends from various factors:

e.g. motor current, motor speed, ambient temperature, duty cycle, forced draft, heat flow from motor to other bodies, ...

For extreme applications STÖGRA offers motors with extended operating temperature:

type	temperature range
Z240	-30°C until 100°C (short time until 120°C)
Z80	-30°C until 120°C (short time until 130°C)

Ordering examples: SM 87.2.18M6 Z240, SM 88.1.18M4 Z80

STÖGRA also offers further versions, e.g. for low temperature until -50°C – please contact us.

### Shaft diameter options for series SM 87 and SM 88 – options Z8 and Z200

The shaft diameter for series SM 87 is Ø10mm (dimension D2 in drawing page 5) for the standard »M« version (metrical dimensions). Standard shaft diameter for series SM 88 is Ø12mm.

Optionally motors SM 87 and SM 88 are available with following shaft diameters (dimension D2):

SM 87 with Ø12mm: option »Z8« – SM 87... M...Z8 (e.g. SM 87.2.18M4,6 Z8)

SM 88 with Ø10mm: option »Z200« – SM 88... M...Z200 (e.g. SM 88.2.18M8 Z200)

Also other customer specific shaft diameters and modifications are possible.

### Metalic back cover for STÖGRA stepper motor series SM 87, SM 88 and SM 107 – Option Z48

In standard version series SM 87, SM 88 and SM 107 are delivered with a PVC back cover.

Only SM 56 and SM 168 are delivered in standard version with metalic back cover.

But optionally series SM 87, SM 88 and SM 107 also are available with metalic back cover (aluminium).

The metalic cover may be used e.g. for mounting an external encoder at motors with second shaft end.

ordering example: SM 87.3.18M3,5W Z48

### Vacuum compatible motors series SM ... V and SM ... V Z138



For vacuum and clean room applications we offer our vacuum compatible series SM ...V and SM ...V Z138.

Specifications:

- vakuum compatible until 10<sup>-6</sup> Torr
- blank stator surface
- vacuum compatible special bearing grease
- for leads motor versions including teflon leads
- metalic back cover (aluminium)
- motors are not gased out!

Ordering example: SM 87.3.18M6V

The option Z138 additionally includes a galvanically nickled motor surface (protection against corrosion for the blank stator).

Ordering example: SM 87.3.18M6V Z138

These options are available for all **STÖGRA** motor series (but not for options brake or encoder).

## 28 stepper motor special versions

### IP68 motors – Z9 and Z177

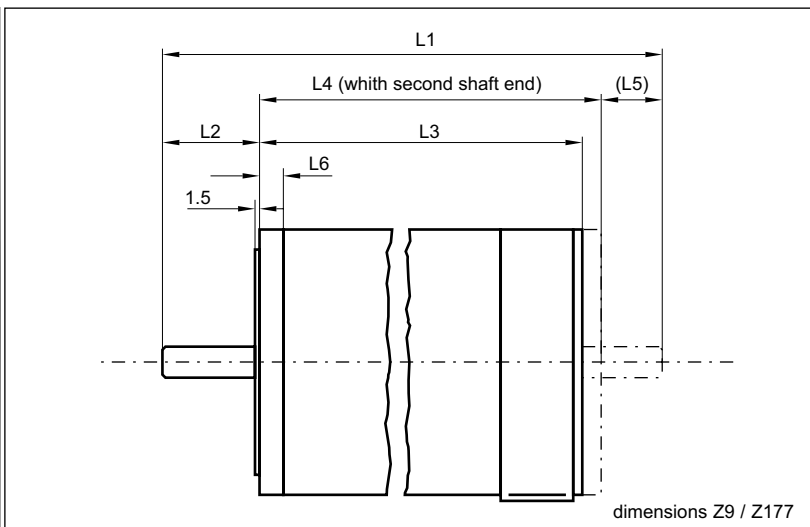

All motor series from **STÖGRA** are available optionally with **protection class IP68** <sup>3)</sup>.

The IP68 motors are tested under water with 1 bar pressure (corresponds to operation of motor in 10m water depth).

Typical applications for IP68 motors are, beside underwater, any plants outside (e.g. faced to rain) or in the food industry, where motors are cleaned with water.

The motors include special sealings and some special parts as special flanges.

Options »brake« and »encoder« are also possible for IP68 motors.

IP68 motors need to be ordered with the extension »Z9« in the type designation.

Ordering example: SM 87.2.18M6 E50 Z9

Generally we recommend to order our **IP68** motors **with additional special coating** for protection against corrosion (see also below Z119 und Z177).

Ordering key for **Z9 and special coated: Z177**

mm motor type	L1	L2 ±0.5	L3 ±0.5	L4 ±0.5	L5 ±0.5	L6
SM 56.1.18	108	17.2	79.8	81.3	9.5	5
SM 56.2.18	134		105.8	107.3		
SM 56.3.18	162		133.8	135.3		
SM 87.1.18	137	27	90	97	13	11.5
SM 87.2.18	169		122	129		
SM 87.3.18	201		154	161		
SM 87.4.18	233		186	193		
SM 88.1.18	145	27	98	105	13	11.5
SM 88.2.18	177		130	137		
SM 88.3.18	209		162	169		
SM 88.4.18	241		194	201		
SM 107.1.18	170	32	111	116	22	9
SM 107.2.18	238	50	161	166		
SM 107.3.18	288		211	216		
SM 107.4.18	338		261	266		

<sup>3)</sup> IP68 according to DIN 40050 / EN60529 / IEC529 – IP58 according to VDE0530-5 / EN60034-5 / IEC34-5

### Motors with special coating for protection against corrosion Z119 / Z177



All **STÖGRA** motors are available optionally with special coating.

The complete motor surface will be primed two times and then specially coated. This guarantees an extremely robust protection of the complete motor surface against corrosion.

Typically motors in IP68 version (see above Z9) or motors in IP55 (standard-cast connection box version) for the food industry are ordered in special coated version.

Coated motors in IP55 (standard cast connection box) must be ordered with the extension »Z119«. Ordering example: SM 87.2.18M6 E50 Z119

Coated motors in IP68 version (see above »Z9«) must be ordered with the extension »Z177«. Ordering example: SM 87.2.18M6 E50 Z177

Motors usable in **sea water environment** are also available (please contact us for more informations).

Following table shows possible combinations for stepping motors and controls / drivers (see **STÖGRA**-catalogue stepping motor controls).

SE **z.i.u** ... e.g. SE 800.06.85 V33  
                   **z**   **i**   **u**

**z**: steps per revolution 200, 400, 500, 800, 1000 or P05

SERS **i.u** ... e.g. SERS 06.85 V04 E50  
                   **i**   **u**

**i**: current per phase 01 A until 12 A

**u**: voltage supply 24 VDC until 240 VDC

To match the right stepping motor, the important parameters in the controls designations are **i** and **u**.

□ = possible combinations		SE z.02.24 / SERS 02.24	SE z.02.60 / SERS 02.60	SE z.03.24 / SERS 03.24	SE z.03.60 / SERS 03.60	SE z.04.24 / SERS 06.24	SE z.04.85 / SERS 06.85	SE z.04.120 / SERS 06.120	SE z.06.24 / SERS 06.24	SE z.06.85 / SERS 06.85	SE z.06.120 / SERS 06.120	SE z.08.85 / SERS 12.85	SE z.08.120 / SERS 12.120	SE z.12.85 / SERS 12.85	SE z.12.120 / SERS 12.120	SE z.12.240 / SERS 12.240	WSE / WSERS 04.80	WSE / WSERS 08.80	WSE / WSERS 04.230 AC	WSE / WSERS 06.230 AC
		<b>series 56</b>	SM 56.1.18 J1	□	□														□	
	SM 56.1.18 J3			□	□		□										□			
	SM 56.1.18 J3.9					□	□											□		
	SM 56.2.18 J1.5	□	□														□			
	SM 56.2.18 J2	□	□														□			
	SM 56.2.18 J3			□	□		□										□			
	SM 56.3.18 J1.5	□	□														□			
	SM 56.3.18 J3			□	□		□										□			
	SM 56.3.18 J4.6								□	□	□							□		
<b>series 87</b>	SM 87.x.18 M2 <sup>1)</sup>	□	□				□	□									□			□
	SM 87.x.18 M4 <sup>1)</sup>			□	□		□	□									□			□
	SM 87.1.18 M1.6	□	□														□			
	SM 87.1.18 M3			□	□		□										□			
	SM 87.1.18 M5								□	□	□							□		
	SM 87.2.18 M3.5					□	□	□										□		
	SM 87.2.18 M4.6								□	□	□							□		
	SM 87.2.18 M6								□	□	□							□		
	SM 87.3.18 M3.5					□	□	□										□		
	SM 87.3.18 M6								□	□	□							□		
	SM 87.3.18 M7											□	□					□		
	SM 87.4.18 M6								□	□	□							□		
	SM 87.4.18 M7											□	□					□		
<b>series 88</b>	SM 88.x.18 M2 <sup>1)</sup>	□	□				□	□									□			□
	SM 88.x.18 M4 <sup>1)</sup>			□	□		□	□									□			□
	SM 88.x.18 M8 <sup>1)</sup>								□	□	□							□		
	SM 88.3.18 M12												□	□						
	SM 88.4.18 M12												□	□						
<b>series 107</b>	SM107.1.18 M4																			□
	SM107.1.18 M6								□	□	□							□		
	SM107.1.18 M8								□	□	□							□		
	SM107.1.18 M12												□	□						
	SM107.2.18 M4																			□
	SM107.2.18 M8									□	□							□		
	SM107.2.18 M10										□	□								
	SM107.2.18 M12												□	□						
	SM107.3.18 M6																			□
	SM107.3.18 M10										□	□								
	SM107.3.18 M12												□	□						
	SM107.4.18 M6																			□
	SM107.4.18 M12												□	□	□					
<b>series 168</b>	SM 168.1.18 M12													□	□	□				
	SM 168.2.18 M12													□	□	□				

<sup>1)</sup> SM 88.x stands for SM 88.1, SM 88.2, SM 88.3 and SM 88.4

## 30 overview: stepping motor with gear, encoder and brake

STÖGRA-stepping motors are available with various equipment:

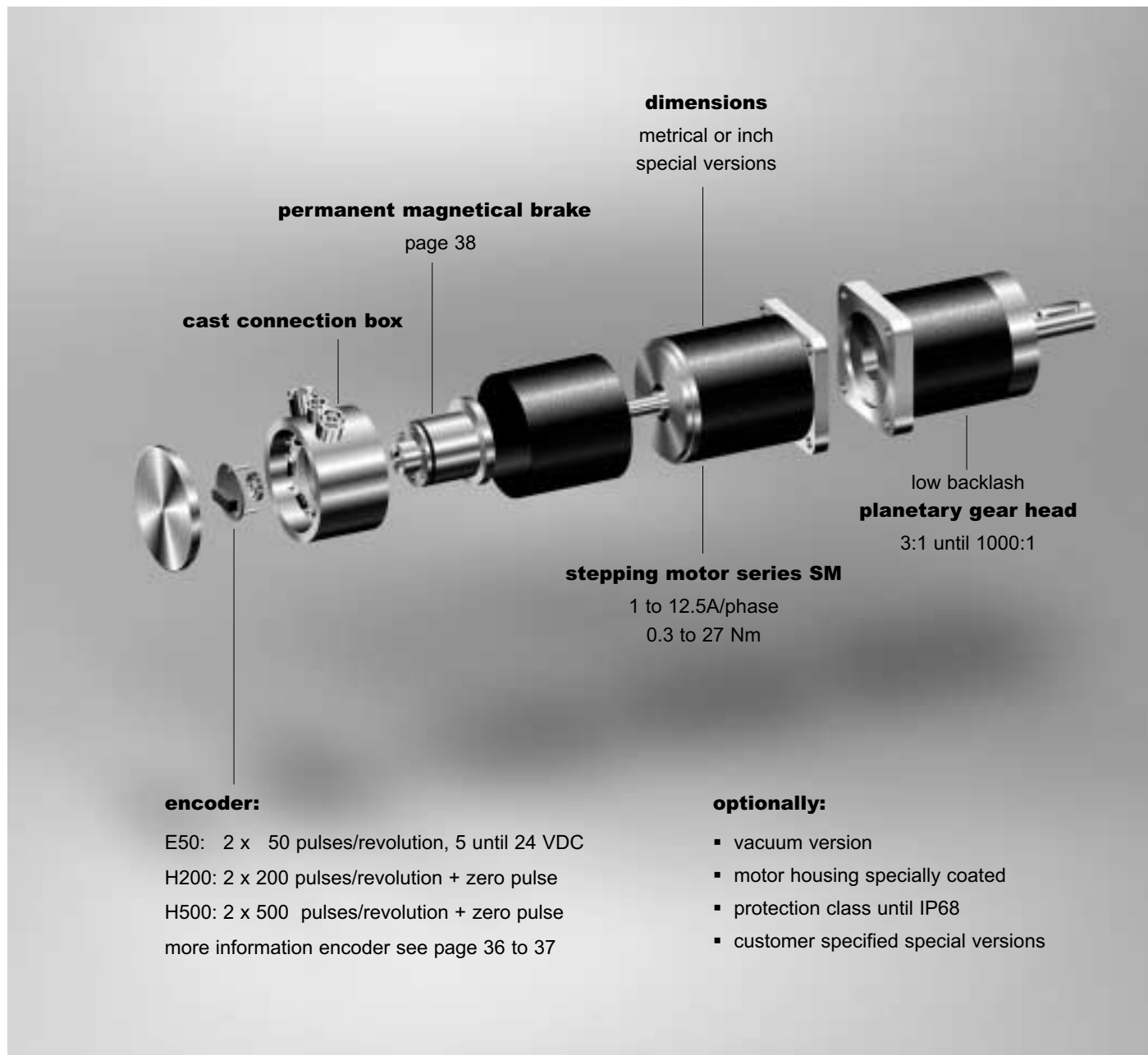

### Options for gear heads:

Gear head series PE and series PR, which are described at the following pages, together with stepper motors are available optionally with **special coating Z119** (see page 26).

Ordering example SM 87.2.18M6 PE40 **Z119**

Gear heads of the serie PE are available optionally with **protection class IP65**.

The gear bos is sealed specially, and the gear head output shaft and the keyway are made of stainless steel.

Ordering indication together with a motor is e.g. SM 87.2.18M6 PE40 **Z9**.

Ordering indication additionally with special coating for protection against corrosion is e.g. SM 87.2.18M6 PE40 **Z177** (see also page 26).

Gear head series PE can also be delivered in angled version (**angled gear heads** series WPE).

**Precision gear heads** series PLN with very low backlash from 3 to 5 angular minutes are available also with **STÖGRA** stepper motors.

Detailed informations for gear head series WPE and PLN are available on request.

# Stepping motor with planetary gear head series SM 56 PE **31**

degree of protection: <b>IP54</b> torque shaft bearing: <b>ball bearing</b> max. axial load: <b>600 N</b> based on the center of the output shaft max. radial load: <b>500 N</b> lubrication: <b>life time lubrication</b> operating temperature: <b>-25°C/+90°C</b> mounting position: <b>any</b>	<b>motor type</b>	<b>length</b> <b>L3 ± 1</b> mm	<b>inertia</b> kgcm <sup>2</sup>
	SM 56.1.18	76	0.125
	SM 56.2.18	102	0.25
	SM 56.3.18	130	0.375

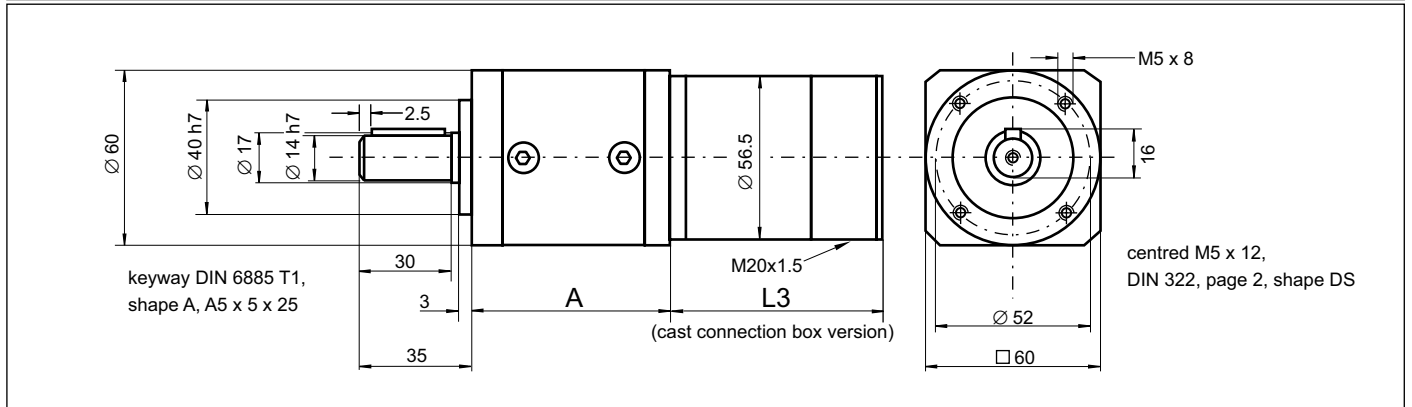

planetary gear head series PE											
type	ratio	max. torque output Nm			inertia referred to motor shaft 10 <sup>-2</sup> kgcm <sup>2</sup>	stiffness of distortion Nm/arcmin	absolute backlash angular minutes	efficiency approx. %	length A mm	weight without motor kg	number of stages
		SM 56.1	SM 56.2	SM 56.3							
PE3	3	1.1	2	3.2	2.3	<10	96	55	0.65	1	
<b>PE4</b>	4	1.5	2.7	4.3							
PE5	5	1.9	3.8	5.4							
<b>PE8</b>	8	3.1	5.4	8.6							
PE9	9	3.3	5.7	9.2	2.5	<12	94	67	0.82	2	
PE12	12	4.4	7.7	12.2							
PE15	15	5.5	9.6	15.3							
PE16	16	5.7	10.2	16.3							
PE20	20	7.3	12.8	20.4							
PE25	25	9.1	15.9	25.5							
PE32	32	11.7	20.4	32.6							
<b>PE40</b>	40	14.6	25.5	40							
PE64	64	18	18	18	2.5	<15	90	80	1	3	
PE60	60	20.6	36	44							
PE80	80	27.5	44	44							
PE100	100	34.4	44	44							
PE120	120	41.3	44	44							
PE160	160	44	44	44							
PE200	200	40	40	40							
PE256	256	44	44	44							
PE320	320	40	40	40							
PE512	512	18	18	18	0.1						

ordering indication: (example) SM 56.2.18J3 PE8

bold faced types: preferential versions (on stock)

output torques are limited by the nominal output torque of the gear heads

# 32 Stepping motor with planetary gear head series SM 56 PRA

degree of protection: <b>IP64</b> torque shaft bearing: <b>ball bearing</b> max. axial load: <b>330 N</b> based on the center of the output shaft max. radial load: <b>220 N</b> lubrication: <b>life time lubrication</b> operating temperature: <b>-25°C to +90°C</b> (short time +120°C) mounting position: <b>any</b>	<b>motor type</b>	<b>length L3 ± 1</b> mm	<b>inertia</b> (without gear head) kgcm <sup>2</sup>
	SM 56.1.18	76	0.125
	SM 56.2.18	102	0.25
	SM 56.3.18	130	0.375

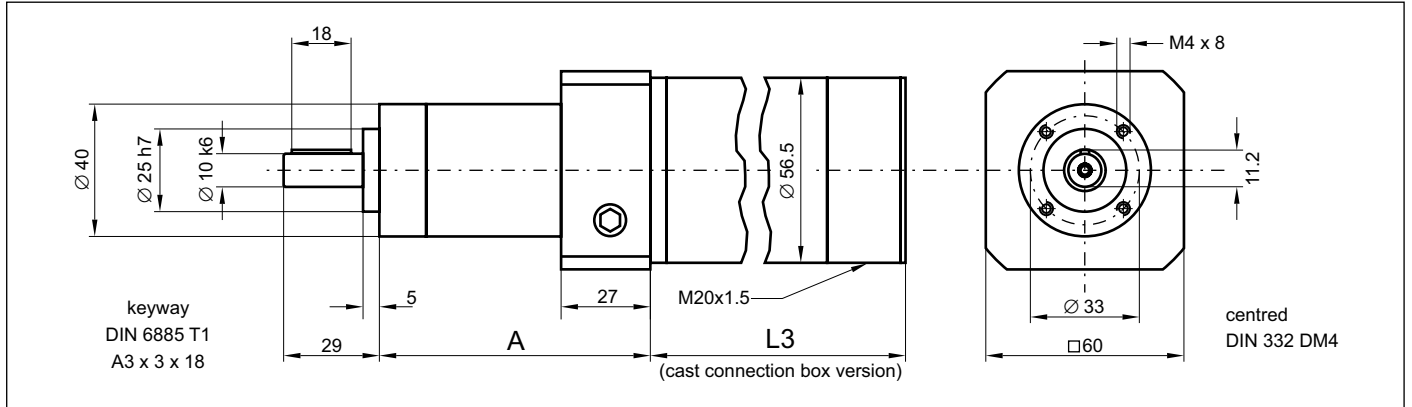

planetary gear head series PRA											
type	ratio	max. torque output Nm			inertia referred to motor shaft 10 <sup>-2</sup> kgcm <sup>2</sup>	stiffnes of distortion Nm/arcmin	absolute backlash angular minutes	efficiency approx. %	length A mm	weight without motor kg	number of stages
		SM 56.1	SM 56.2	SM 56.3							
PRA4	4	1.5	2.7	4	0.4	<20	96	66	0.3	1	
PRA5	5	1.9	3.8	4.5							
PRA7	7	2.7	4.5	4.5							
PRA9	9	3.4	4	4							
PRA16	16	5			0.060	0.5	<25	94	82	0.4	2
PRA20	20				0.058						
PRA25	25				0.058						
PRA28	28				0.058						
PRA35	35				0.057						
PRA49	49				0.057						
PRA64	64	5			0.03	0.6	<30	90	93	0.5	3
PRA80	80				0.03						
PRA100	100				0.03						
PRA140	140				0.03						
PRA175	175				0.03						
PRA245	245				0.03						
PRA343	343				0.03						
PRA729	729				0.03						

ordering indication: (example) SM 56.2.18 M3 PRA20

bold faced types: preferential versions (on stock)  
 output torques are limited by the nominal output torque of the gear heads



# Stepping motor with planetary gear head series SM 56 PR **33**

degree of protection: <b>IP64</b> torque shaft bearing: <b>ball bearing</b> max. axial load: <b>1080 N</b> based on the center of the output shaft max. radial load: <b>930 N</b> lubrication: <b>life time lubrication</b> operating temperature: <b>-25°C to +90°C</b> (short time +120°C) mounting position: <b>any</b>	<b>motor type</b>	<b>length L3 ± 1</b> mm	<b>inertia</b> (without gear head) kgcm <sup>2</sup>
	SM 56.1.18	76	0.125
	SM 56.2.18	102	0.25
	SM 56.3.18	130	0.375

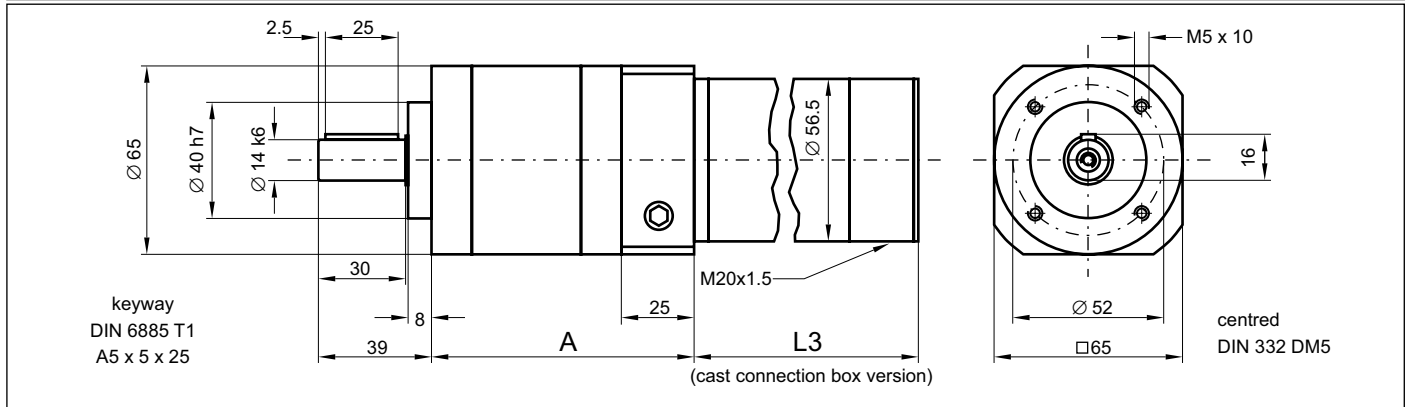

planetary gear head series PR												
type	ratio	max. torque output Nm			inertia referred to motor shaft 10 <sup>-2</sup> kgcm <sup>2</sup>	stiffness of distortion Nm/arcmin	absolute backlash angular minutes	efficiency approx. %	length A mm	weight without motor kg	number of stages	
		SM 56.1	SM 56.2	SM 56.3								
PR3	3	1.1	2	3.2	1.6	12	97	90.5	1.3	1		
PR4	4	1.5	2.7	4.3								
PR5	5	1.9	3.8	5.4								
PR7	7	2.7	5.3	7.6								
PR10	10	3.8	7.6	10.8								
PR16	16	5.7	10.2	16.3	2	15	94	114.5	1.7	2		
PR20	20	7.3	12.8	19								
PR25	25	9.1	15.9	21								
PR28	28	10.2	17.8	21								
PR35	35	12.7	21	21								
PR40	40	14.6	21	21								
PR50	50	18.2	21	21								
PR70	70	17	17	17	2.1	20	90	132	2	3		
PR100	100	16	16	16								
PR120	120	21	21	21								
PR160	160	21	21	21								
PR200	200	21	21	21								
PR250	250	21	21	21								
PR350	350	21	21	21								
PR500	500	21	21	21								
PR700	700	19	19	19								
PR1000	1000	18	18	18								

ordering indication: (example) SM 56.2.18 M3 PR10

bold faced types: preferential versions (on stock)

output torques are limited by the nominal output torque of the gear heads

# 34 Stepping motor with planetary gear head series SM 87 PE / SM 88 PE

degree of protection: <b>IP54</b> torque shaft bearing: <b>ball bearing</b> max. axial load: <b>1200 N</b> based on the center of the output shaft max. radial load: <b>950 N</b> lubrication: <b>life time lubrication</b> operating temperature: <b>-25°C to +90°C</b> mounting position: <b>any</b>	motor type	Length L3 ± 1 mm	inertia (without gear head) kgcm <sup>2</sup>
	SM 87.1.18	85.5	0.65
	SM 87.2.18	117.5	1.3
	SM 87.3.18	149.5	1.95
	SM 87.4.18	181.5	2.6
	SM 88.1.18	93.5	1.35
	SM 88.2.18	125.5	2.7
	SM 88.3.18	157.5	4.05
	SM 88.4.18	189.5	5.4

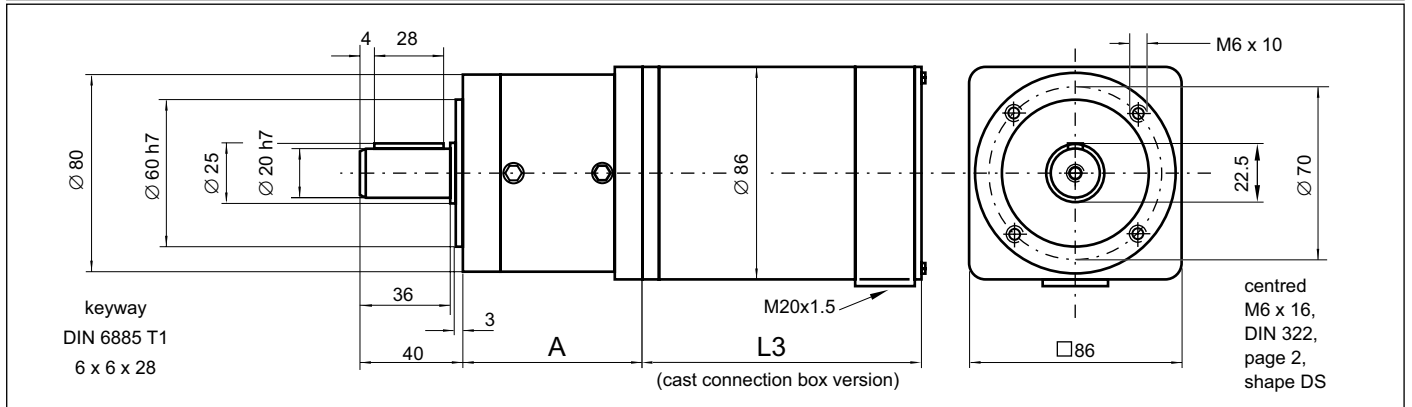

planetary gear head series PE																
type	ratio	max. torque output Nm								inertia referred to motor shaft 10 <sup>-2</sup> kgcm <sup>2</sup>	stiffness of distortion Nm/arcmin	absolute backlash angular minutes	efficiency approx. %	Length A mm	weight without motor kg	number of stages
		SM 87.1	SM 88.1	SM 87.2	SM 88.2	SM 87.3	SM 88.3	SM 87.4	SM 88.4							
PE3	3	4.3	7.2	8.6	14.4	12.9	21.6	17.3	28.8	63	6	<7	96	72 (93.5) (at SM 88.4)	1.6	1
PE4	4	5.8	9.6	11.5	19.2	17.2	28.8	23	38.4	25						
PE5	5	7.2	12	14.4	24	21.6	36	28.8	48	14						
PE8	8	11.5	19.2	23	38.4	34.5	50	46.1	50	8						
PE9	9	12.7	21.1	25.4	42.3	38	63.4	50.7	84.6	63	6.5	<9	94	89 (110.5) (at SM 88.4)	2.2	2
PE12	12	16.9	28.2	33.8	56.4	50.7	84.6	67.7	112.8	26						
PE15	15	21.2	35.2	42.3	70.5	63.4	105.8	84.6	110	62						
PE16	16	22.6	37.6	45.1	75.2	67.6	112.8	90.2	120	25						
PE20	20	28.2	47	56.4	94	84.6	120	112.8	120	15						
PE25	25	35.3	58.7	70.5	110	105.7	110	110	110	15						
PE32	32	45.1	75.2	90.2	120	120	120	120	120	8						
PE40	40	56.4	94	110	110	110	110	110	110	8						
PE64	64	50	50	50	50	50	50	50	50	6						
PE60	60	81	110	110	110	110	110	110	110	25	6.3	<11	90	106.5 (127) (at SM 88.4)	2.8	3
PE80	80	108	120	120	120	120	120	120	120	18						
PE100	100	120	120	120	120	120	120	120	120	15						
PE120	120	110	110	110	110	110	110	110	110	60						
PE160	160	120	120	120	120	120	120	120	120	8						
PE200	200	110	110	110	110	110	110	110	110	8						
PE256	256	120	120	120	120	120	120	120	120	8						
PE320	320	110	110	110	110	110	110	110	110	6						
PE512	512	50	50	50	50	50	50	50	50	6						

ordering indication: (example) SM SM 87.1.18 M3 PE8

bold faced types: preferential versions (on stock)  
 output torques are limited by the nominal output torque of the gear heads

# Stepping motor with planetary gear head series SM 87 PR / SM 88 PR 35

degree of protection: <b>IP64</b> torque shaft bearing: <b>ball bearing</b> max. axial load: <b>2180 N</b> based on the center of the output shaft max. radial load: <b>1770 N</b> lubrication: <b>life time lubrication</b> operating temperature: <b>-25°C to +90°C</b> (short time +120°C) mounting position: <b>any</b>	motor type	Length L3 ± 1 mm	inertia (without gear head) kgcm <sup>2</sup>
	SM 87.1.18	85.5	0.65
	SM 87.2.18	117.5	1.3
	SM 87.3.18	149.5	1.95
	SM 87.4.18	181.5	2.6
	SM 88.1.18	93.5	1.35
	SM 88.2.18	125.5	2.7
	SM 88.3.18	157.5	4.05
	SM 88.4.18	189.5	5.4

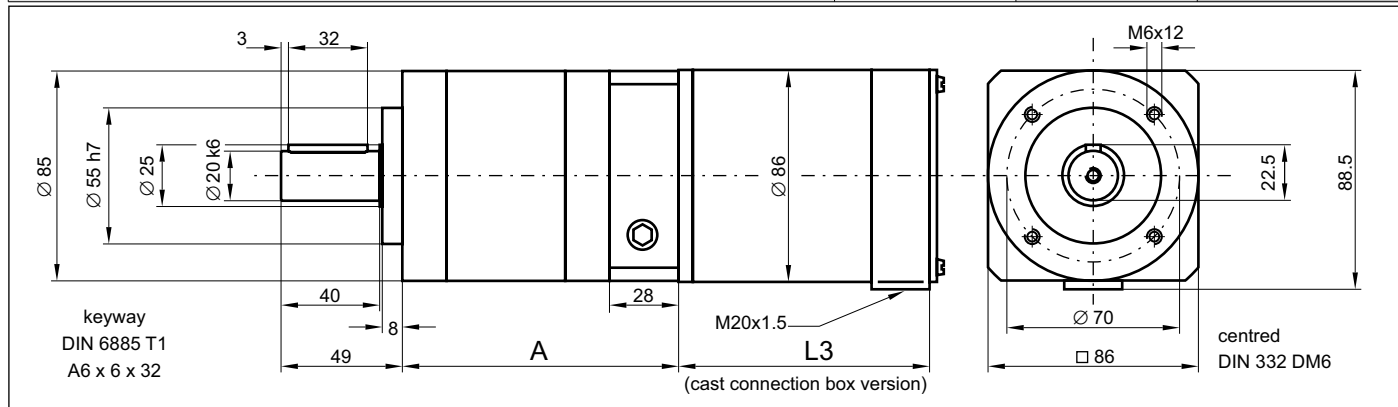

planetary gear head series PR																		
type	ratio	max. torque output Nm								inertia referred to motor shaft 10 <sup>-2</sup> kgcm <sup>2</sup>	stiffness of distortion Nm/arcmin	absolute backlash angular minutes	efficiency approx. %	Length A mm	weight without motor kg	number of stages		
		SM 87.1	SM 88.1	SM 87.2	SM 88.2	SM 87.3	SM 88.3	SM 87.4	SM 88.4									
PR3	3	4.3	7.2	8.6	14.4	12.9	21.6	17.3	28.8	1.62	4.8	10	96	112	2.6	1		
PR4	4	5.8	9.6	11.5	19.2	17.2	28.8	23	38.4	1.44								
PR5	5	7.2	12	14.4	24	21.6	36	28.8	48	1.36								
PR7	7	10.1	16.8	20.2	33.6	30.2	43	40.3	43	1.30								
PR10	10	14.4	24	28.8	35	35	35	35	35	1.27								
PR16	16	22.6	37.6	45.1	55	55	55	55	55	1.42	6	15	94	143	3.5	2		
PR20	20	28.2	47	55	55	55	55	55	55	1.35								
PR25	25	35.3	58	58	58	58	58	58	58	1.35								
PR28	28	39.5	55	55	55	55	55	55	55	1.29								
PR35	35	49.5	58	58	58	58	58	58	58	1.29								
PR40	40	55	55	55	55	55	55	55	55	1.26								
PR50	50	58	58	58	58	58	58	58	58	1.26								
PR70	70	50	50	50	50	50	50	50	50	1.26								
PR100	100	35	35	35	35	35	35	35	35	1.20								
PR120	120	55	55	55	55	55	55	55	55	0.34							5.5	20
PR160	160	55	55	55	55	55	55	55	55	0.34								
PR200	200	58	58	58	58	58	58	58	58	0.34								
PR250	250	58	58	58	58	58	58	58	58	0.34								
PR350	350	58	58	58	58	58	58	58	58	0.34								
PR500	500	58	58	58	58	58	58	58	58	0.34								
PR700	700	50	50	50	50	50	50	50	50	0.34								
PR1000	1000	35	35	35	35	35	35	35	35	0.34								

ordering indication: (example) SM SM 87.2.18 M6 PR10

bold faced types: preferential versions (on stock)  
 output torques are limited by the nominal output torque of the gear heads

# 36 Stepping motor with planetary gear head series SM 107 PE

degree of protection: <b>IP54</b> torque shaft bearing: <b>ball bearing</b> max. axial load: <b>2800 N</b> based on the center of the output shaft max. radial load: <b>2000 N</b> lubrication: <b>life time lubrication</b> operating temperature: <b>-25°C to +90°C</b> mounting position: <b>any</b>	<b>motor type</b>	<b>Length L3 ± 1</b> mm	<b>inertia</b> (without gear head) kgcm <sup>2</sup>
	SM 107.1.18	111	4
	SM 107.2.18	161	8
	SM 107.3.18	211	12
	SM 107.4.18	261	16

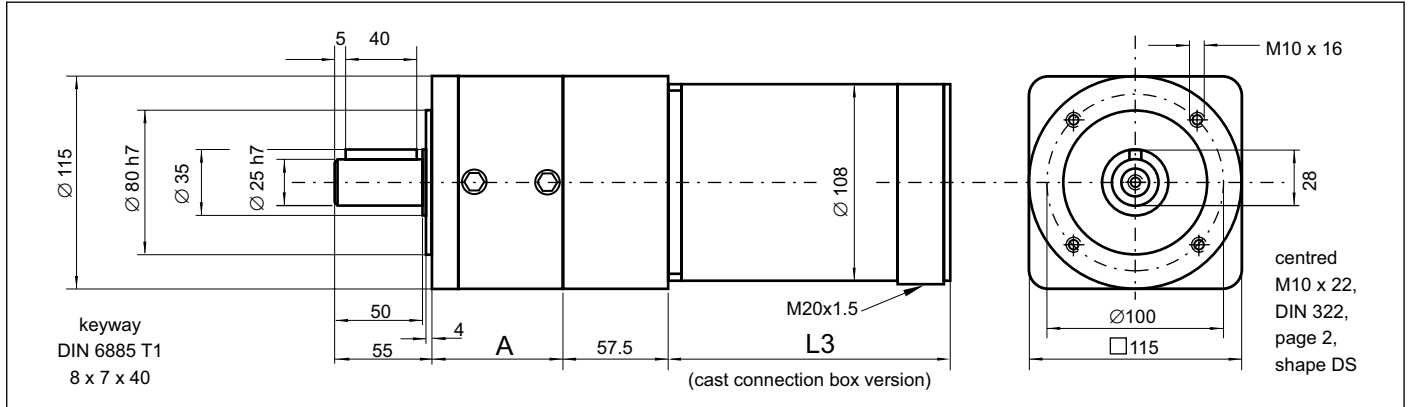

planetary gear head series PE												
type	ratio	max. torque output Nm				inertia referred to motor shaft 10 <sup>-2</sup> kgcm <sup>2</sup>	stiffnes of distortion Nm/arcmin	absolute backlash angular minutes	efficiency approx. %	Length A mm	weight without motor kg	number of stages
		SM 107.1	SM 107.2	SM 107.3	SM 107.4							
PE3	3	10.8	20.8	29.7	39.4	2.6	12	<7	96	74	6.5	1
<b>PE4</b>	4	14.4	27.7	39.6	52.6	1.79						
PE5	5	18	34.7	49.5	65.7	1.53						
<b>PE8</b>	8	28.8	55.4	79.2	105	1.32						
PE9	9	30.6	58.9	84.2	112	2.62	13	<9	94	101	9	2
PE12	12	40.8	78.5	112	149	2.56						
PE15	15	51	98.2	140	186	2.53						
PE16	16	54.4	105	150	198	1.75						
PE20	20	68	131	187	248	1.5						
PE25	25	85	164	230	230	1.49						
PE32	32	109	209	260	260	1.3						
<b>PE40</b>	40	136	230	230	230	1.3						
PE64	64	120	120	120	120	1.3	12	<11	90	128	11.5	3
PE60	60	192	260	260	260	2.57						
PE80	80	256	260	260	260	1.5						
PE100	100	260	260	260	260	1.5						
PE120	120	230	230	230	230	2.5						
PE160	160	260	260	260	260	1.3						
PE200	200	230	230	230	230	1.3						
PE256	256	260	260	260	260	1.3						
PE320	320	230	230	230	230	1.3						
PE512	512	120	120	120	120	1.3						

ordering indication: (example) SM 107.2.18 M12 PE8

bold faced types: preferential versions (on stock)  
 output torques are limited by the nominal output torque of the gear heads

# Stepping motor with planetary gear head series SM 107 PR **37**

degree of protection: <b>IP64</b> torque shaft bearing: <b>ball bearing</b> max. axial load: <b>3730 N</b> based on the center of the output shaft max. radial load: <b>3000 N</b> lubrication: <b>life time lubrication</b> operating temperature: <b>-25°C to +90°C</b> (short time +120°C) mounting position: <b>any</b>	<b>motor type</b>	<b>Length L3 ± 1</b>	<b>inertia</b> (without gear head)
		mm	kgcm <sup>2</sup>
	SM 107.1.18	111	4
	SM 107.2.18	161	8
	SM 107.3.18	211	12
	SM 107.4.18	261	16

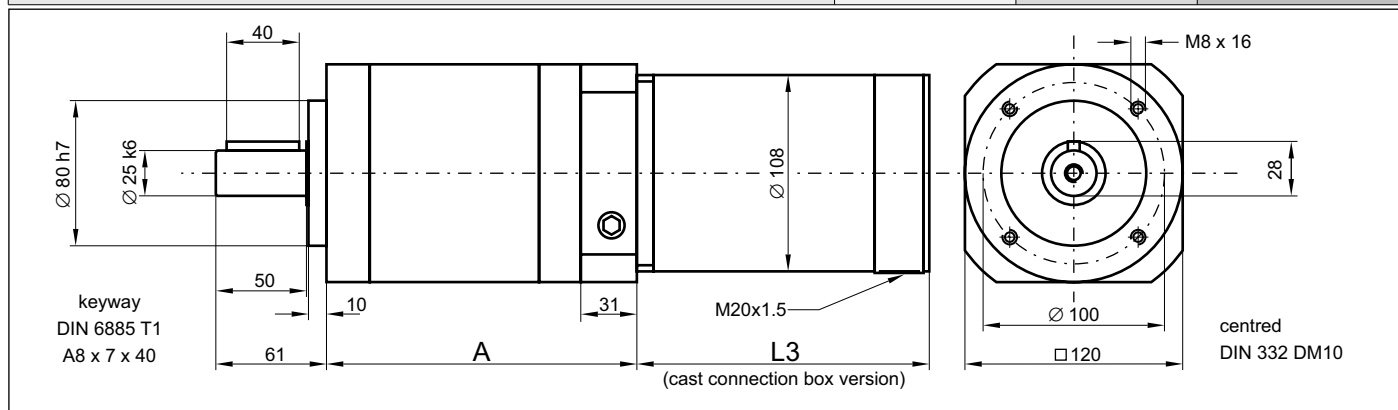

planetary gear head series PR												
type	ratio	max. torque output Nm				inertia referred to motor shaft 10 <sup>-2</sup> kgcm <sup>2</sup>	stiffness of distortion Nm/arcmin	absolute backlash angular minutes	efficiency approx. %	Length A mm	weight without motor kg	number of stages
		SM 107.1	SM 107.2	SM 107.3	SM 107.4							
PR3	3	10.8	20.8	29.7	39.4	10	10	96	135	6	1	
<b>PR4</b>	4	14.4	27.7	39.6	52.6							
<b>PR5</b>	5	18	34.7	49.5	65.7							
<b>PR7</b>	7	25.5	48.6	69.3	90							
<b>PR10</b>	10	36	69.4	80	80							
<b>PR16</b>	16	54.4	100	100	100	13	15	94	171	8.6	2	
<b>PR20</b>	20	68	100	100	100							
<b>PR25</b>	25	85	110	110	110							
<b>PR28</b>	28	95.2	100	100	100							
<b>PR35</b>	35	110	110	110	110							
<b>PR40</b>	40	100	100	100	100							
<b>PR50</b>	50	110	110	110	110							
<b>PR70</b>	70	95	95	95	95							
<b>PR100</b>	100	85	85	85	85							
PR120	120	100	100	100	100							
PR160	160	100	100	100	100	12	20	90	195	10	3	
PR200	200	100	100	100	100							
PR250	250	110	110	110	110							
PR350	350	110	110	110	110							
PR500	500	110	110	110	110							
PR700	700	95	95	95	95							
PR1000	1000	70	70	70	70							

ordering indication: (example) SM 107.2.18 M12 PR10

bold faced types: preferential versions (on stock)  
 output torques are limited by the nominal output torque of the gear heads

## 38 stepping motor – equipment

### Stepping motor with integrated encoder

In non disturbed operation the stepping motor runs synchronously to the pulses coming from the control, that means the motor rotation (= rotation of the rotor) is synchronously to the pulse frequency (= rotating stator field in the motor).

In case of a load at the motor (e.g. via a static load at the motor shaft or because of accelerating the motor – dynamical load) the running of the motor will differ from the pulse frequency within a short time and within a certain max range. This results in changing the load angle (= difference between the real position of the rotor and its position command value).

### Stepping motor with integrated encoder E50

The encoder series E50 monitors the motion of the motor. Together with a **STÖGRA**-drive series SE... E50 or SERS .. E50 the load angle of the stepping motor can be controlled. When exceeding the max. load angle allowed (e.g. in case of the motor running is interrupted because of a mechanical overload) the drive will create an error signal.



#### special characteristics

- simple and robust low cost version
- no changes of the motor dimensions in comparison to the standard version with cast connection box (except SM 56)
- the encoder is integrated in the motor housing. There is no additional measure necessary for protection – available until IP68
- all requirements for mechanical and climatical ambient conditions (vibration-, shock resistance, temperature and humidity) are fulfilled.
- evaluation of the encoder signals and realisation of a step angle control with generating an error signal can be done by using standard **STÖGRA**.

### Specifications E50

#### electrical specifications

voltage supply: 5 to 24VDC

current consumption: typ. approx 35mA (no load at outputs) – max. load at outputs 100mA / output

operating temperature: -40 to 125°C

#### outputs

- 2 x 50 pulses per revolution – signals A and B with rectangular shape and inverted signals A and B
- duty cycle 1:1 ± max. 20% error
- Bipolar – switching to VCC and GND
- short circuit protected signals against GND
- pulse frequency min. 20 kHz

#### signal outputs

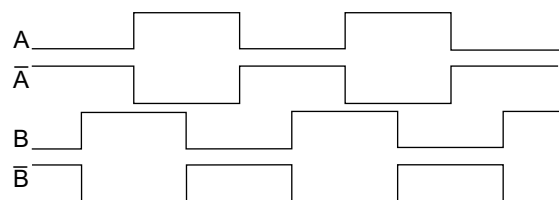

#### connections

connection via screw terminals for nominal cross section max. 1mm<sup>2</sup> (26 – 16AWG)

optionally also available with connector (see pages 22 – 24)

dimensions as standard motor types! (except series SM56 – see table page 39)

**Stepping motor with integrated encoder H200 and H500****special characteristics**

- the encoder is integrated in the motor housing. There is no additional measure necessary for protection
- available until protection class IP68
- all requirements for mechanical and climatical ambient conditions (vibration-, shock resistance, temperature and humidity) are fulfilled
- evaluation of the encoder signals and realisation of a step angle control with generation of an error signal can be done by using standard **STÖGRA** controls SERS...E50...

**Technical specifications H200 and H500****general specifications H200 and H500**

- optical encoder
- voltage supply: 5 VDC
- operating temperature: -40 to 100°C

**outputs**

- 2 x 200 pulse per revolution for H200  
2 x 500 pulse per revolution for H500  
rectangular shape signals A und B,  
with inverted signals A and B
- H200 and H500: zero pulse  
and inverted zero pulse – 1 pulse per revolution
- duty cycle 1:1 ± max. 10% error
- RS422-line driver
- short circuit protected signals against GND
- pulse frequency min. 100 kHz

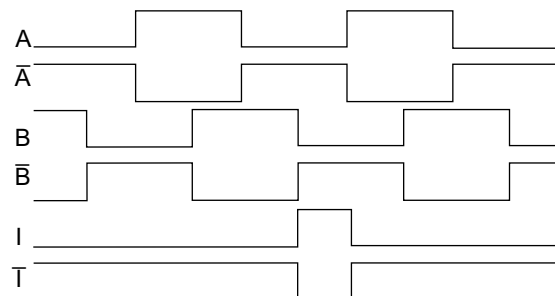
**signal outputs****dimensions**

the modified dimensions – compared to the standard motors without encoder – can be found in the table at page 39

**connections**

connection via screw terminals for nominal cross section max. 1mm<sup>2</sup> (26 –16AWG)  
optionally also available with connector (see pages 22 – 24)

# 40 stepping motor – equipment

## Stepping motor with holding brake

brake type: **permanent magnetical brake**  
 voltage supply: **24VDC (-10% / +15%)**  
 operating temperature: **max. 100°C**  
 protection: **as motor protection – until IP68**  
**the brake is integrated in the motor housing**

Holding brakes are used as emergency brakes in vertical axis (Z-axis). If the motor current is switched off or in case of a power line fault the motor shaft will be retarded.

The brake must be supplied by 24VDC to release the motor shaft.

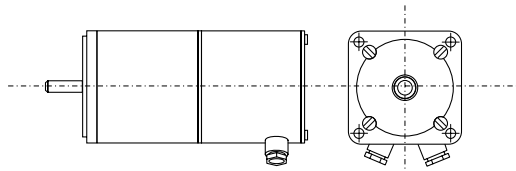

The dimensions of the different motor types with brake can be found in the table of page 39.

stepping motor with holding brake				brake				
series	type	weight kg	rotor inertia		holding torque Nm	switching time		electr. power / consumption at 24 VDC W / mA
			total kgcm <sup>2</sup>	brake kgcm <sup>2</sup>		ON ms	OFF ms	
56	SM 56.1.18...B	0.8	0.15	0.02	1	7	15	10 / 417
	SM 56.2.18...B	1.2	0.27					
	SM 56.3.18...B	1.6	0.4					
87	SM 87.1.18...B	2.1	0.8	0.15	4.5	20	15	12 / 500
	SM 87.2.18...B	3	1.45					
	SM 87.3.18...B	4	2.1					
	SM 87.4.18...B	5	2.75					
88	SM 88.1.18...B	2.3	1.5	0.15	4.5	20	15	12 / 500
	SM 88.2.18...B	3.2	2.85					
	SM 88.3.18...B	4.2	4.2					
	SM 88.4.18...B	5.2	5.55					
107	SM 107.1.18...B	5.2	4.65	0.63	6	35	25	18 / 750
	SM 107.2.18...B	8.1	8.65					
	SM 107.3.18...B	10.7	12.65					
	SM 107.4.18...B	13.4	16.65					

## Connections brake

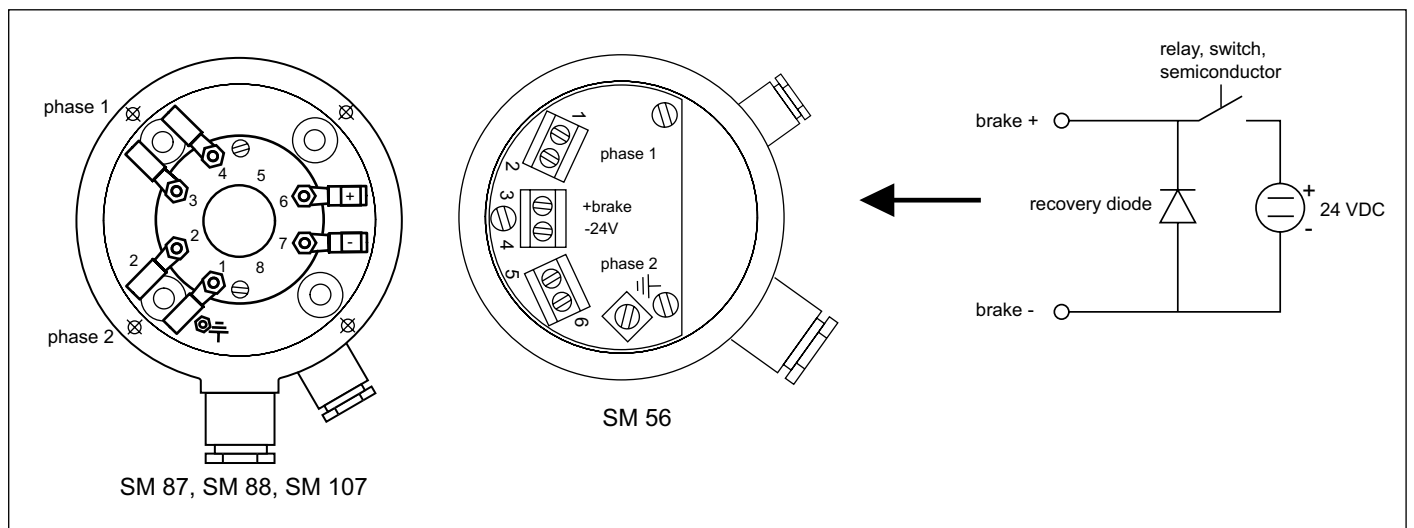



**Dimensions stepping motor with gear box, encoder and brake**

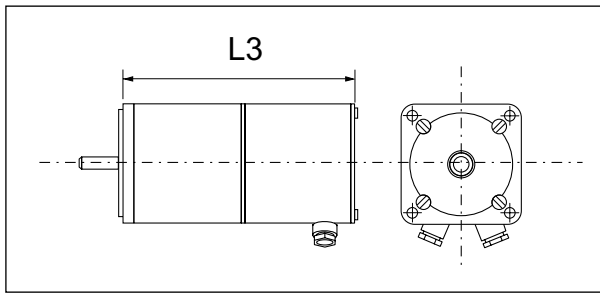

SM 87.2 with brake



SM 87.3 with encoder H200



SM 87.2 with brake and encoder H200

<b>total length</b> L3 ±0.5 mm	<b>standard</b> cast connection box	<b>brake</b>	<b>E50</b>	<b>H200/H500</b>	<b>brake and E50</b>	<b>brake and H200/H500</b>
SM 56.1	76	116	88	98	128	137.5
SM 56.2	102	142	114	124	154	163.5
SM 56.3	130	170	142	152	182	191.5
SM 87.1	85.5	131	85.5	104	131	153
SM 87.2	117.5	163	117.5	136	163	185
SM 87.3	149.5	195	149.5	168	195	217
SM 87.4	181.5	227	181.5	200	227	249
SM 88.1	93.5	139	93.5	112	139	161
SM 88.2	125.5	171	125.5	144	171	193
SM 88.3	157.5	203	157.5	176	203	225
SM 88.4	189.5	235	189.5	208	235	257
SM 107.1	111	168	111	136	168	193
SM 107.2	161	218	161	186	218	243
SM 107.3	211	268	211	236	268	293
SM 107.4	261	318	261	286	318	343
SM 168.1	179		179			
SM 168.2	254		254			

**SM cable gland**



<b>thread</b>	<b>for cable</b> ∅ mm	<b>type key</b>	<b>width across flats</b> mm	<b>connections cast connection box</b>
M16 x 1.5	5...9	KV – M16 x 1.5	17	encoder and brake
M20 x 1.5	9...13	KV – M20 x 1.5	22	stepper motor phases

**metric EMC cable glands:**

- protection type IP68 up to 5 bar
- material brass nickel plated
- for shielded cables
- sealing insert made of neoprene
- O-ring on external thread